

User Guide

MSR 165

Shock & Vibration Data Logger



Table of Contents

1. Necessary Software	3
2. Explanation of Terms	3
3. Pre-Mission Settings	8
3.1 MSR165 Vibration and Shock Mode	8
3.2 MSR165 Vibration Settings.....	8
3.3 MSR165 Shock Settings (Call up Assistant)	10
4. Read Out Measurement Data.....	12
4.1 Reader.....	12
4.2 Card Reader	13
5. Report Function.....	14
5.1 Open File.....	14
5.2 Customised Setting of the Report	16
5.3 Export.....	17
6. Analysing Shock Events and Sensor Recordings	18
6.1 The User Interface	18
7. Setting Menus	20
7.1 Shock Event	20
8. Table 'Shocks'	23
9. Sensor Chart	24
10. Filter and Filter Builder	26
11. Alarm Active	30
12. Customize MSR165 ShockViewer.....	31
13. Spectral Analysis.....	33
13.1 Magnitude FFT	33
13.2 Power Spectrum (Power Spec).....	36

1. Necessary Software

Download the software from website:

MSR PC software (standard): <https://www.msr.ch/en/support/msr-pc-software-standard/>

MSR165 ShockViewer: <https://www.msr.ch/en/support/datalogger-msr-shockviewer-software/>

2. Explanation of Terms

Acceleration max: the resulting acceleration - only this is displayed in the Report.

$$a_R = \sqrt{a_x^2 + a_y^2 + a_z^2}$$

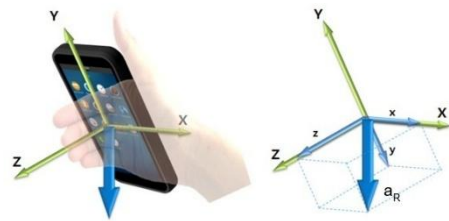

Acceleration Threshold: Is the amplitude of the recorded measured values, the exceeding of which triggers an event recording. Definition according to DIN EN 15433 part 6:

A stochastic impact event is present if the acceleration peak value in at least one spatial axis exceeds the acceleration threshold value $a_{Threshold}$ set for this particular axis and if the impact duration of this event is equal to or greater than a minimum impact duration $T_{Shock}(min)$.

The adjustable threshold value for the acceleration must cover at least the range between **10 % and 75 %** of the actual measured value or the upper limit (DIN EN 15433 Part 6).

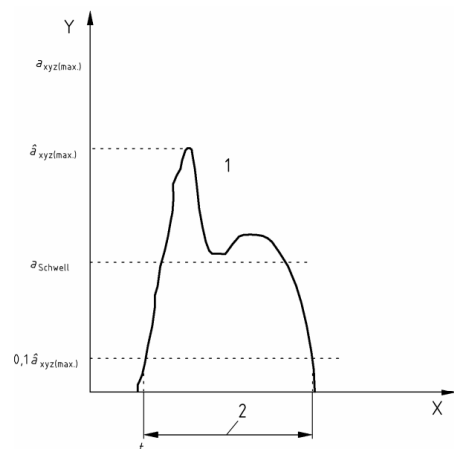

Change of Velocity: Time integral of the acceleration within the shock duration T_{Shock} (not yet available in the software).

$$\Delta v = \int_{t_0}^{t_0+T_{Shock}} a_{xyz(max)} dt$$

The object velocity v can be found in the formula for the pulse I:

$$I = Mass m * v$$

and for the kinetic energy E: $E = \frac{m}{2} v^2$

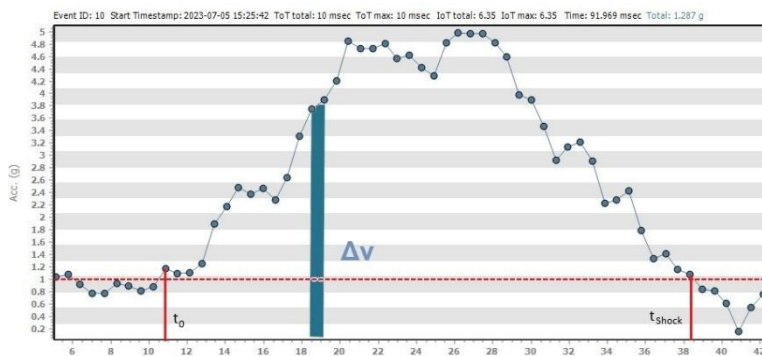

Fast Fourier Transform: For the practical application the Fast Fourier Transformation FFT was developed. This is an algorithm which leads by clever handling of the data substantially faster to the same result as the Discrete Fourier Transformation DFT. Today, the FFT is used everywhere in vibration or shock analysis. By using the inverse FFT, the original signal can be restored here as well.

$$f(t) = A_0 + \sum_{k=1}^{\infty} \left(\frac{A_k - iB_k}{2} e^{i\omega_k t} + \frac{A_k + iB_k}{2} e^{-i\omega_k t} \right)$$

Simplification : $C_0 = A_0$ $C_k = \frac{A_k - iB_k}{2}$ $-C_k = \frac{A_k + iB_k}{2}$

it follows: $f(t) = \sum_{-\infty}^{\infty} C_k e^{i\omega_k t}$

$$C_k = \frac{1}{T} \int_{-T/2}^{T/2} F(t) \cos(\omega t) dt$$

Real Part: $R(\omega) = \int_{-T/2}^{T/2} f(t) \cos(\omega t) dt$

Imaginary parts: $I(\omega) = i \int_{-T/2}^{T/2} f(t) \sin(\omega t) dt$

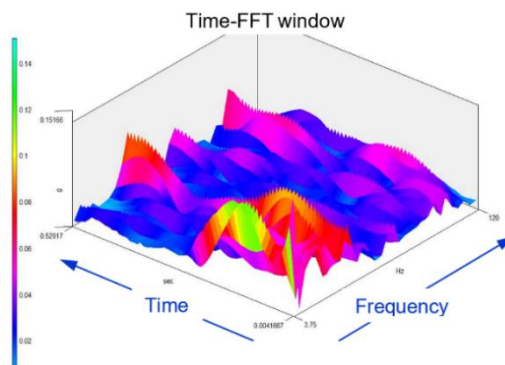

IoT (Intensity over Threshold): This is the time integral of the acceleration within the shock duration T_{Shock} , above the threshold value (non-dimensional). This value is used to select and sort the shock events.

$$IoT = \int_{t_0}^{t_0 + T_{Shock}} (a_R(t) - Th(t)) dt$$

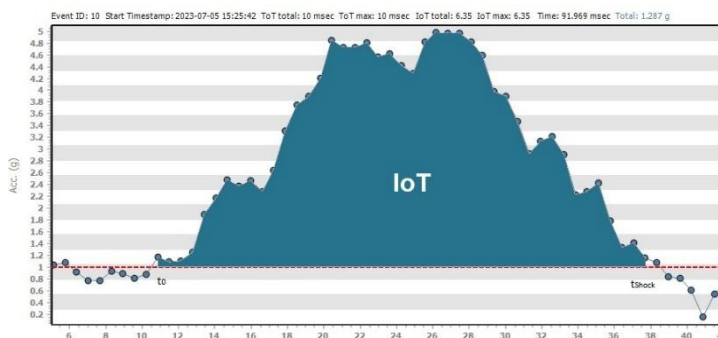

Magnitude FFT: Refers to the absolute (all positive: *magnitude* = $abs(x)$) value of the Fast Fourier Transformation (FFT) results, which allows for the analysis of the frequency components of a signal. The magnitude is the square root of the sum of the squared coefficients, also known as the Fourier-transformed:

$$F(\omega) = a + bi = \sqrt{R(\omega)^2 + I(\omega)^2}$$

The magnitude has the unit $g=9.81 m/s^2$.

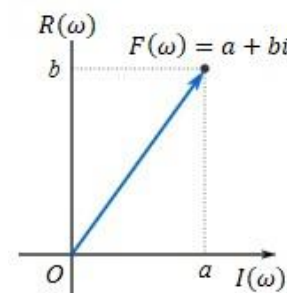

Nyquist–Shannon Sampling Theorem: Is an essential principle for digital signal processing linking the frequency f_m range of a signal and the sample rate f_s required to avoid a type of distortion called aliasing.

The theorem states that the sample rate must be at least twice the bandwidth of the signal to avoid aliasing. The Formula for Nyquist Sampling Theorem can be given as

$$f_s \gg 2 \cdot f_m$$

f_s refers to frequency signal (sampling rate).

f_m refers to max spectral frequency.

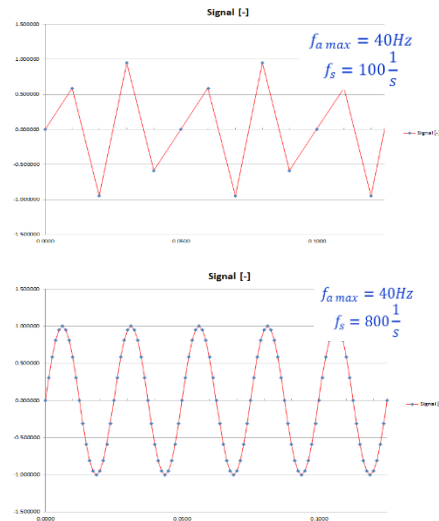

Power Spectrum: The power spectrum is a general term that describes the distribution of power contained in a signal as a function of frequency. From this point of view, a power spectrum can be defined over a discrete set of frequencies (applicable to infinitely long periodic signals) or a power spectrum defined as a continuous function of frequency (applicable to infinitely long aperiodic signals). Do not confuse the power spectrum with the spectral power density!

$$PowerSpec[i] = SpectrumSize \cdot \frac{Magnitude[i]^2}{2}$$

The power spectrum has the unit g^2 .

SpectrumSize, RealSpec, ImagSpec: Using Fast Fourier Transform is very simple. First, insert as many FFT components as needed into a form and specify the correct size(s) of the data array by setting the 'SpectrumSize' property. To calculate the fourier spectrum, fill the 'RealSpec' array property with the data and call the transform method. After that, the results of the transform are available through the array properties 'RealSpec' (real part of the complex spectrum) and 'ImagSpec' (imaginary part). Dividing 'RealSpec' and 'ImageSpec' gives the 'Phase Angle' φ_n .

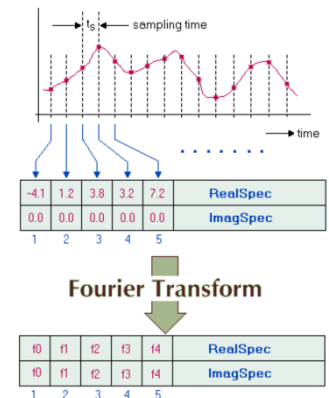

Sampling rate: In signal processing, **sampling** is the reduction of a continuous-time signal to a discrete-time signal. A common example is the conversion of a sound wave to a sequence of "samples". A **sample** is a value of the signal at a point in time and/or space; this definition differs from the term's usage in statistics, which refers to a set of such values.

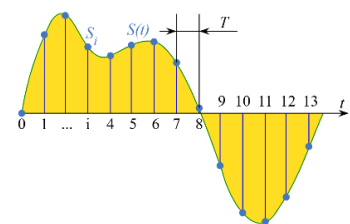

ToT (Time over Threshold): For each shock event recorded, the pulse durations in msec in which the shock amplitude has exceeded the pre-set g-value threshold (from the MSR data logger PC configurator) and subsequently fallen short of it again are ascertained.

$$ToT = t_2 - t_1$$

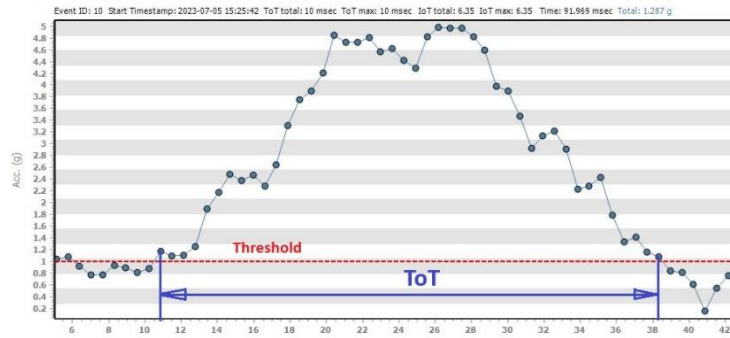

Weighting Functions: The array ‘WgtFunction’ contains ‘SpectrumSize’ coefficients which are multiplied with the corresponding data elements before the fourier transform takes place. The index *i* may assume values between 1 and ‘SpectrumSize’. By default, the weights are all set to 1.0, thus implementing a rectangle window function.

Rectangle	$f(x) = 1 \text{ for } x \leq N$ $f(x) = 0 \text{ for } x > N$
Triangle	$f(x) = 1 - x /N \text{ for } x \leq N$ $f(x) = 0 \text{ for } x > N$
Cos2	$f(x) = \cos^2(x/N)$
Gauss	$f(x) = \exp(-(\alpha x/N)^2)$
Hamming	$f(x) = 0.54 + 0.46 \cdot \cos(x/N)$
Blackman	$f(x) = 0.42 + 0.50 \cdot \cos(x/N) + 0.08 \cdot \cos(2x/N)$
Blackman-Harris	$f(x) = 0.359 + 0.488 \cdot \cos(x/N) + 0.141 \cdot \cos(2x/N) + 0.012 \cdot \cos(2x/N)$
Blackman-Nuttall	$f(x) = 0.364 + 0.489 \cdot \cos(x/N) + 0.137 \cdot \cos(2x/N) + 0.011 \cdot \cos(2x/N)$

Please note that choosing the right window is always a compromise and is a kind of art. Moreover, the cosine bell window, the Hamming window and the general Tukey window are closely related. The general Tukey window is defined by the following function:

$$f(x) = 1 - 2a + 2a \cdot \cos\left(\frac{x}{N}\right)$$

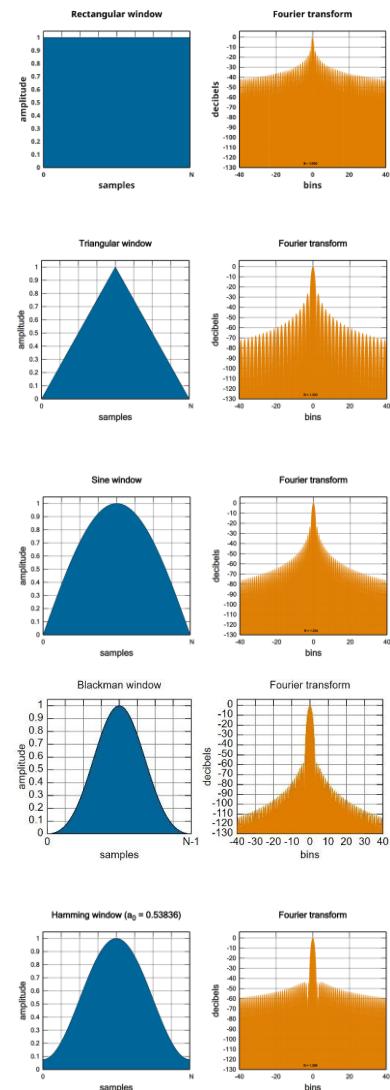

The parameter a determines the type of the window:

Hamming window: $a = 0,23$

Hanning window: $a = 0,25$

Please note that the resulting equation for the Hanning window can be converted to the \cos^2 function by simple trigonometric calculations.

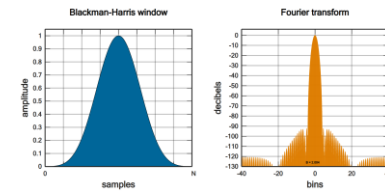
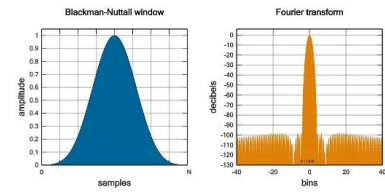

3. Pre-Mission Settings

3.1 MSR165 Vibration and Shock Mode

The settings for the MSR165 data logger are made in the MSR PC software (standard).

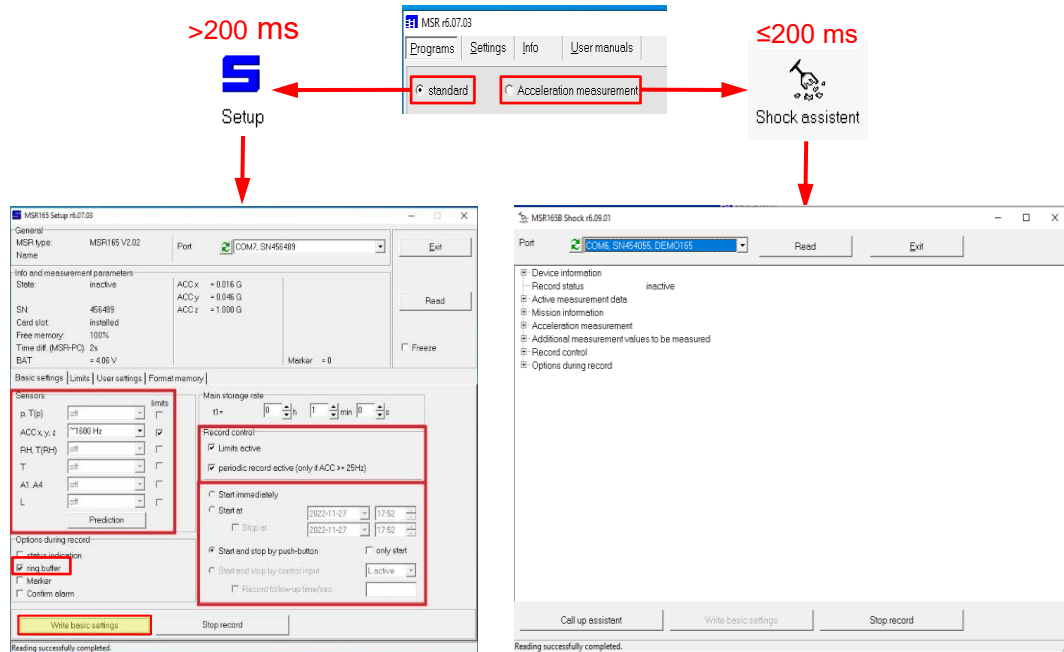

- status indication
- ring buffer
- Marker
- Confirm alarm

Important note for vibration and shock mode:

If a microSD card is installed in the data logger, the ring buffer, overwrite mode for the internal flash memory must be set!

3.2 MSR165 Vibration Settings

For longer shock durations > 200 ms, vibration mode can be used with the limit setting. The limit settings are comparable to a threshold value.

Record control					
<input checked="" type="checkbox"/> Limits active	→	ACCx	<L1 or >L2	inactive	-1.000, 1.000, G
<input type="checkbox"/> periodic record active (only if ACC >= 25Hz)		ACCy	<L1 or >L2	inactive	-1.000, 1.000, G
		ACCz	<L1 or >L2	inactive	0.000, 2.000, G

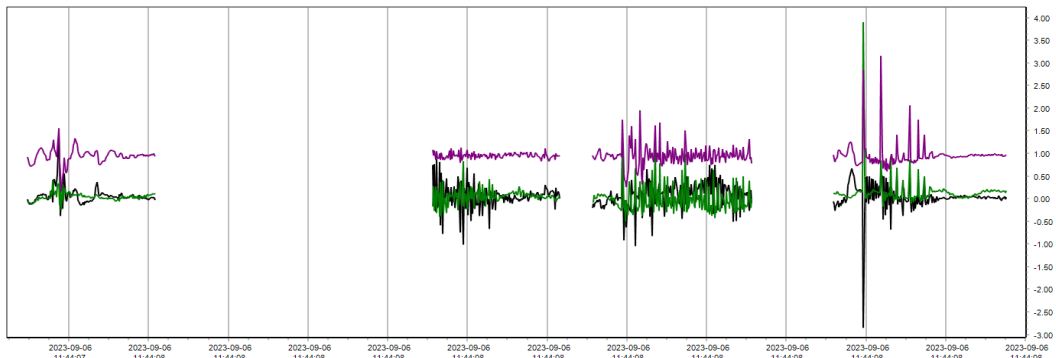

Option: The **'Periodic Record'** option is suitable for longer ship passages. Predefined pauses and recording intervals allow for a considerable extension of the overall measurement time.

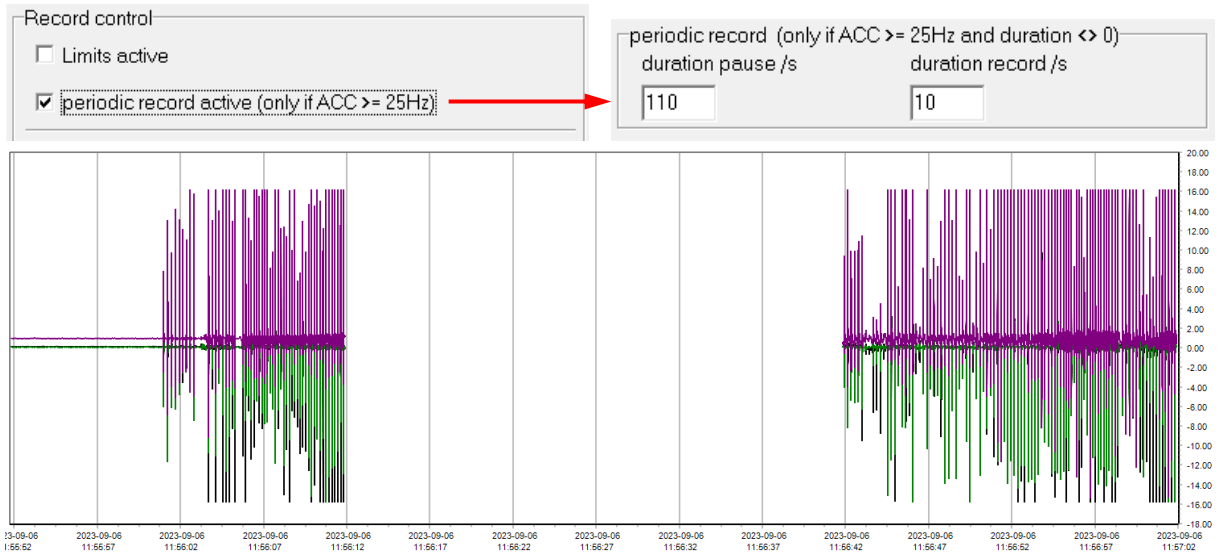

3.3 MSR165 Shock Settings (Call up Assistant)

For shock measurements follow ‘Acceleration measurements’ → ‘Shock assistant’. The ‘Call up assistant’ will guide you through the necessary settings.

Call up assistant

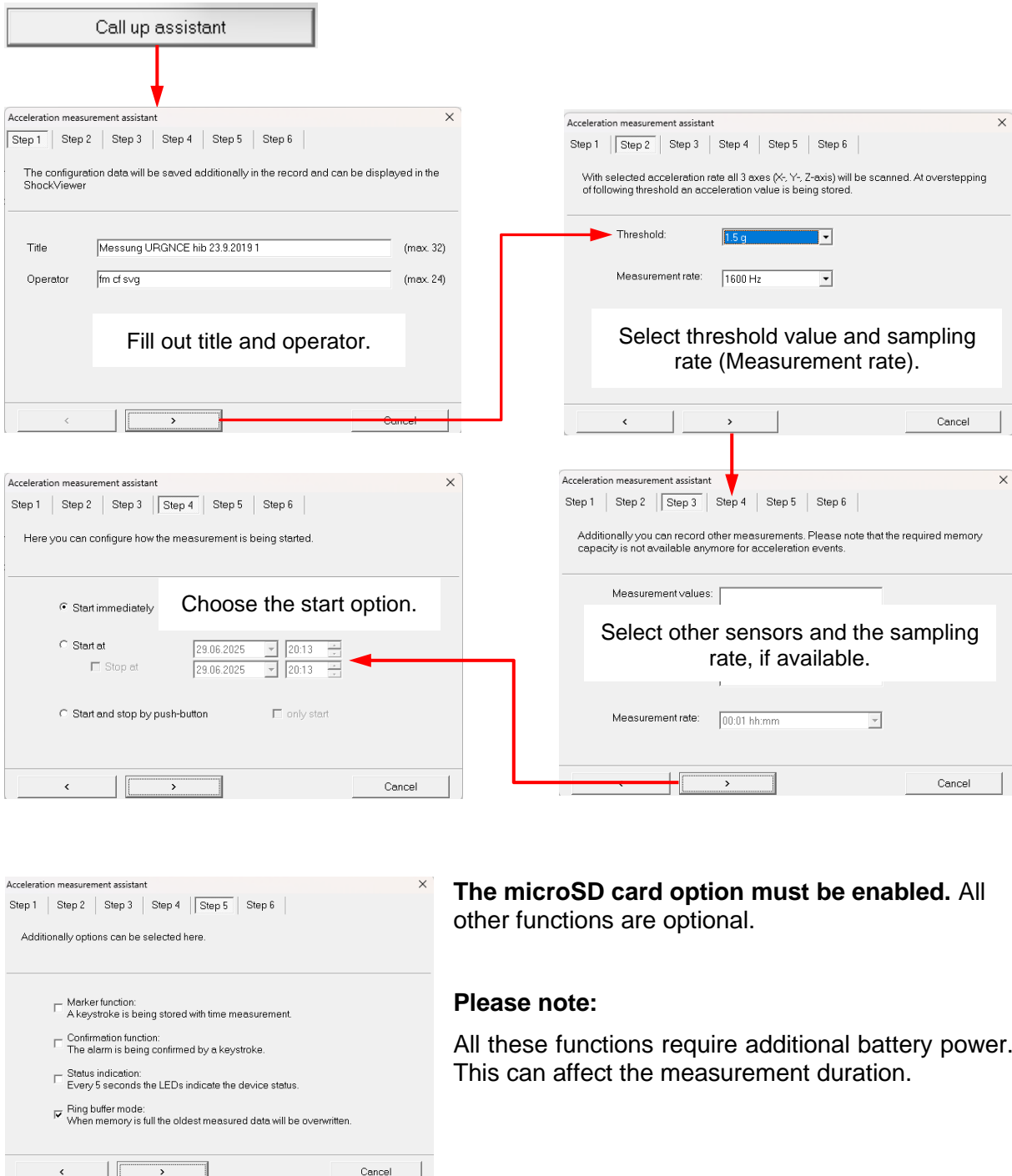

Step 1: Fill out title and operator.

Step 2: Select threshold value and sampling rate (Measurement rate).

Step 3: Choose the start option.

Step 4: Select other sensors and the sampling rate, if available.

Step 5: The microSD card option must be enabled. All other functions are optional.

Please note: All these functions require additional battery power. This can affect the measurement duration.

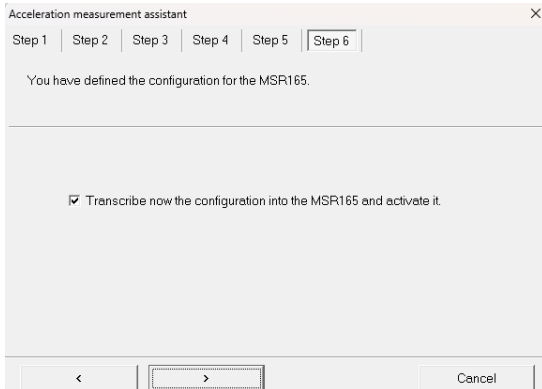

Press the **'forward button'**



to finalize the configuration and write the data to the data logger.

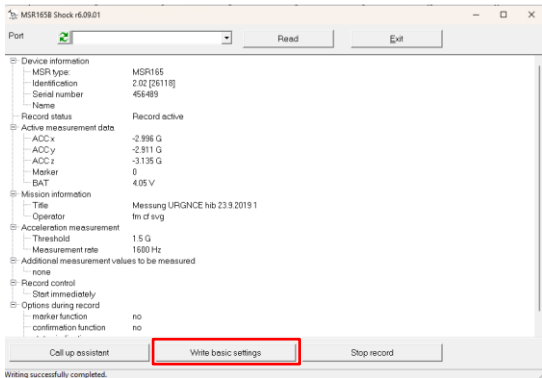

Check the current settings on the first page of the Shock Assistant. If all details are correct, complete the process by selecting **'Write basic settings'**. The data logger is now ready for measurement.

4. Read Out Measurement Data

4.1 Reader

The **'Reader'** only reads the internal flash memory. If your data logger has a microSD card installed, continue with the card reader. You will find the measurement files saved at in the following directory.

Select the files that are to be saved on MSR/Data. Finalise the selection with **'OK'**.

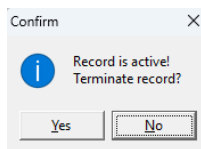
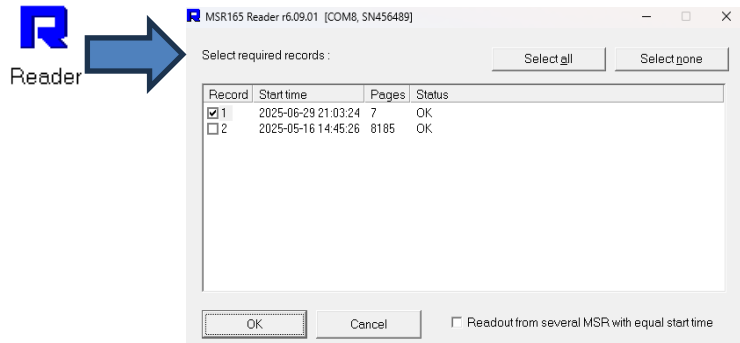

The data logger may still be in operation when it is read out. If this warning appears, press the 'Yes' button.

4.2 Card Reader

To read out a microSD card, remove it from the card slot of the data logger. Use the enclosed card adapter to connect the card to the PC / laptop.

The card reader recognizes the USB connection with the microSD card.

Each card contains two files: **msr.dat** (data container) and the directory file **msr.cfg**.

Do not delete these two files. When the system is restarted, existing data in the data container will be overwritten.

A 32 GB microSD card contains 8 containers of 4 GB each.

This card cannot be reformatted by the user.

Select the appropriate data format:

*.**msr** for data in standard (vibration mode).

*.**mshock** for data in shock mode.

Select the data records you wish to download.

At the end, you can choose whether you want to read the data directly in CSV, start the ShockViewer or write the data to the MSR/Data directory.

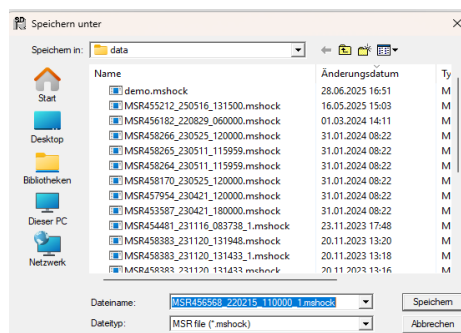
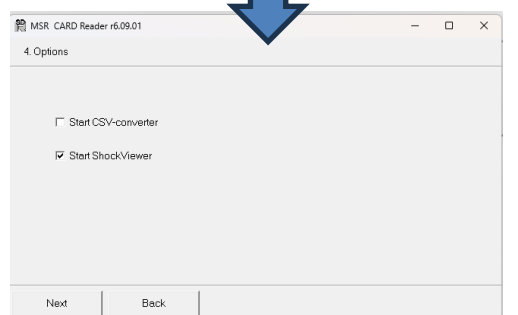
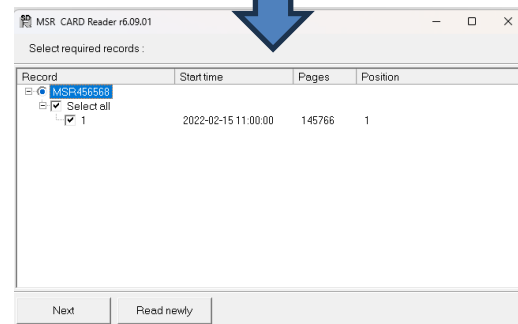
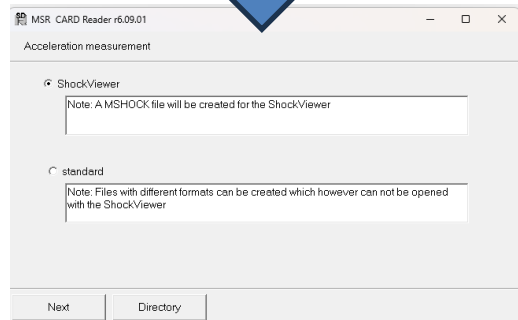
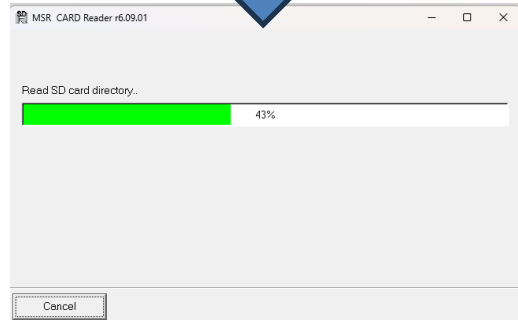

5. Report Function

5.1 Open File

We will learn how to open a data file in 'MSR ShockViewer' and how to get a shock report.

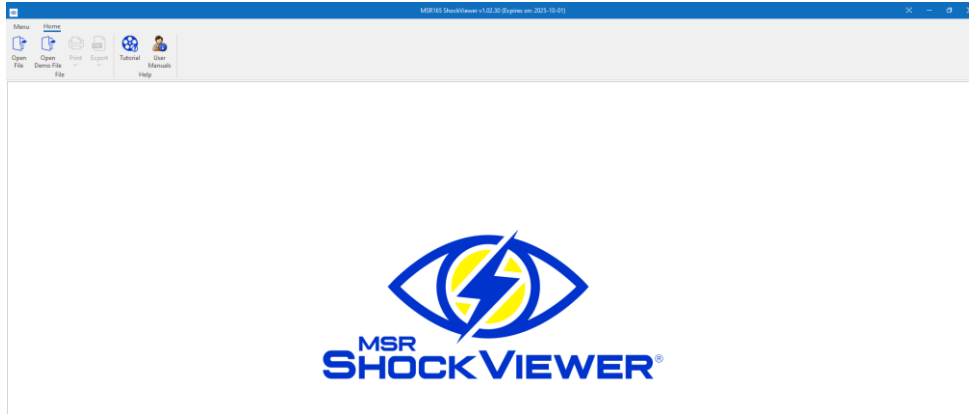

First click the 'Open File' icon and browse to your data file. Select the file and click 'Open' (Example with demo file).

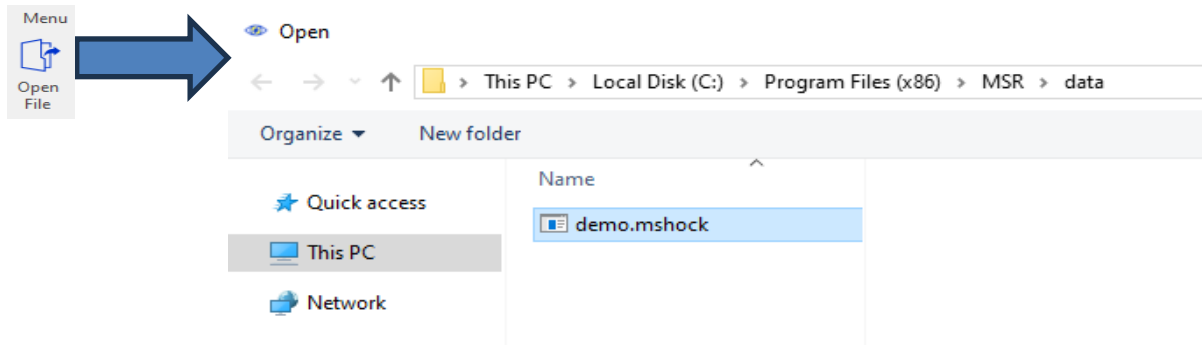

The data is now loaded into the application. The 'Report' view opens by default and provides a comprehensive overview of the measurements captured by your data logger.

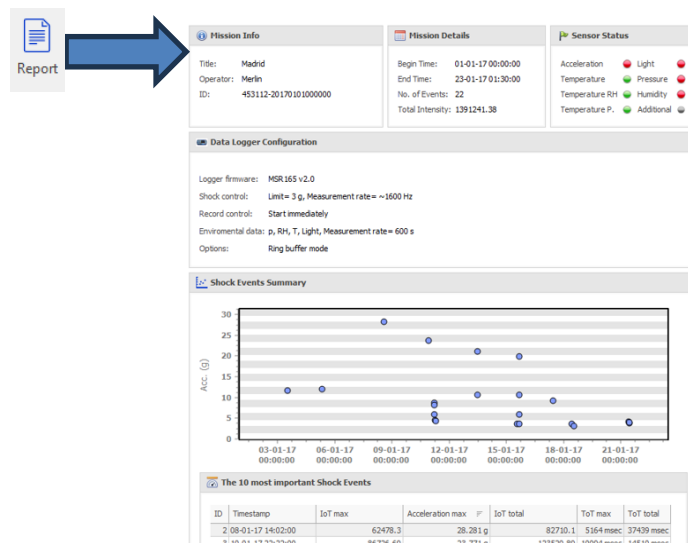

Mission Info: At the top of the report, you will find information about the measurement period, mission information and details about the active sensors on the data logger during the measurement.

Mission Info	Mission Details	Sensor Status
Title: Madrid Operator: Merlin ID: 453112-20170101000000	Begin Time: 01-01-17 00:00:00 End Time: 23-01-17 01:30:00 No. of Events: 22 Total Intensity: 1391241.38	Acceleration ● Light ● Temperature ● Pressure ● Temperature RH ● Humidity ● Temperature P. ● Additional ●

Data Logger Configuration: You will find overall information about the configuration setting of data logger.

Data Logger Configuration
Logger firmware: MSR165 v2.0 Shock control: Limit= 3 g, Measurement rate= ~1600 Hz Record control: Start immediately Enviromental data: p, RH, T, Light, Measurement rate= 600 s Options: Ring buffer mode

Shock Events Summary: The shock events chart displays all shocks measured with a rough indication of time and intensity. In this example the shock with the highest calculated, resulting acceleration a_R occurred on the 8th of January 2017 with an intensity of roughly 28g.

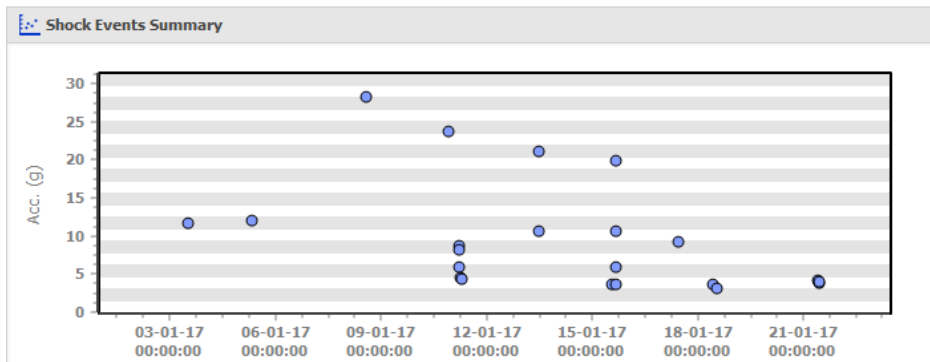

The 10 most intense shock events are listed with detailed information in the table below.

The 10 most important Shock Events						
ID	Timestamp	IoT max	Acceleration max	IoT total	ToT max	ToT total
2	08-01-17 14:02:00	62478.3	28.281 g	82710.1	5164 msec	37439 msec
3	10-01-17 22:22:00	86726.69	23.771 g	123520.89	10094 msec	14510 msec
10	13-01-17 11:52:00	48151.22	21.165 g	52466.88	5156 msec	16758 msec
14	15-01-17 16:04:00	383706.66	19.929 g	442697.53	44508 msec	79125 msec
1	05-01-17 08:17:00	27032.28	12.007 g	342159.75	7079 msec	192423 msec
0	03-01-17 12:43:00	29613.63	11.765 g	29613.63	5502 msec	6113 msec
15	15-01-17 16:11:00	29251.32	10.711 g	30695.47	6250 msec	8750 msec
9	13-01-17 11:19:00	29251.32	10.711 g	30695.47	6250 msec	8750 msec
16	17-01-17 11:04:00	12211.82	9.198 g	71338.11	4443 msec	60303 msec
4	11-01-17 05:16:00	19727.29	8.815 g	30023.41	7047 msec	16656 msec

5.2 Customised Setting of the Report

It is possible to make customized settings for the report. Open the page for the default settings via **'Tutorials' → 'Option'**.

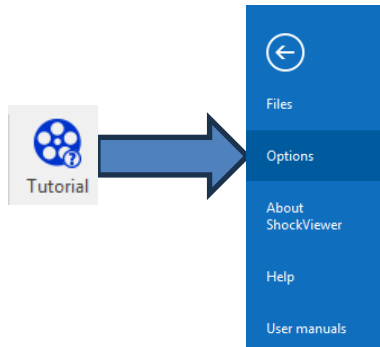

Company settings: Load your own logo and customize the company name.

Date Format: Setup your required data format.

Default File Filter: Only ShockViewer or ShockViewer and Vibration Mode (*.msr).

Most important by: Sort function (top down) by column.

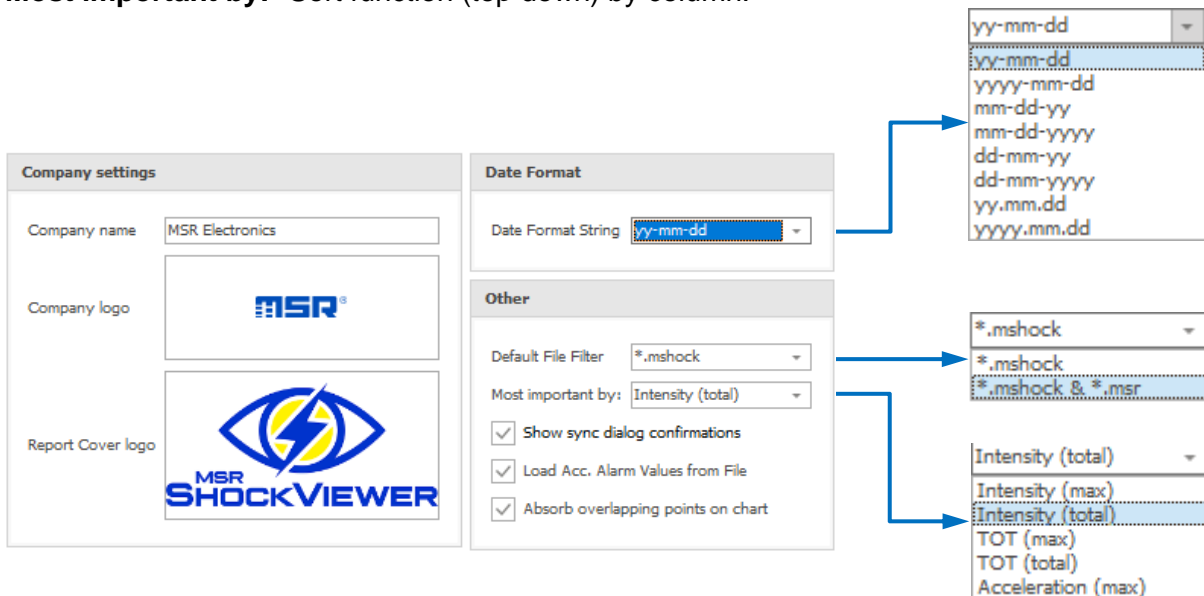

Number of decimal places: enter the number of digits after the decimal point.

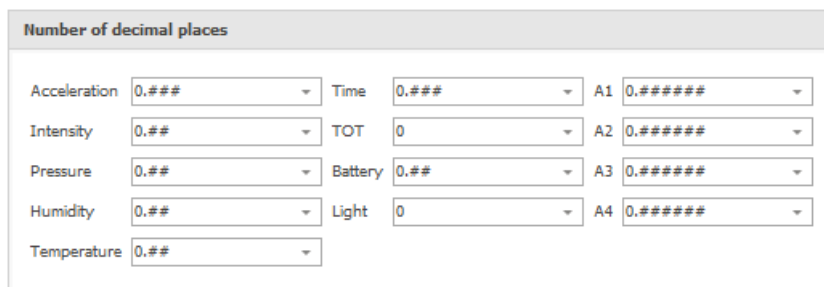

Additional Sensor Labels: Optional for data loggers with analogue inputs. Specify the name for the analogue inputs.

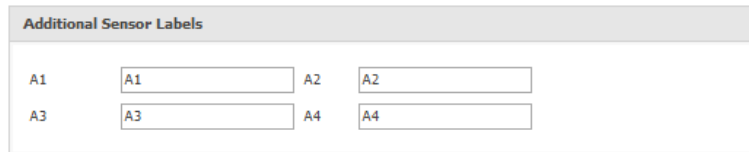

A dialog box titled "Additional Sensor Labels" with four input fields labeled A1, A2, A3, and A4.

Sensor Color Settings: A selection of colors is available for the measurement graphs.

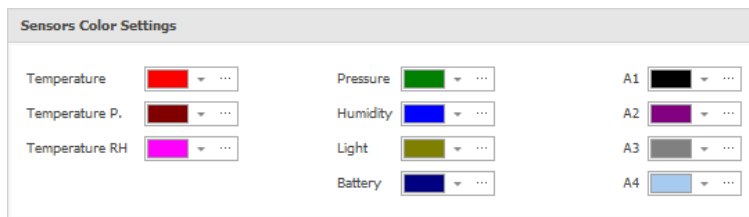

A dialog box titled "Sensors Color Settings" with color selection dropdowns for Temperature, Pressure, Humidity, Light, Battery, and analogue inputs A1, A2, A3, and A4.

5.3 Export

Use the icon 'PDF Export' to export the Report as PDF file.

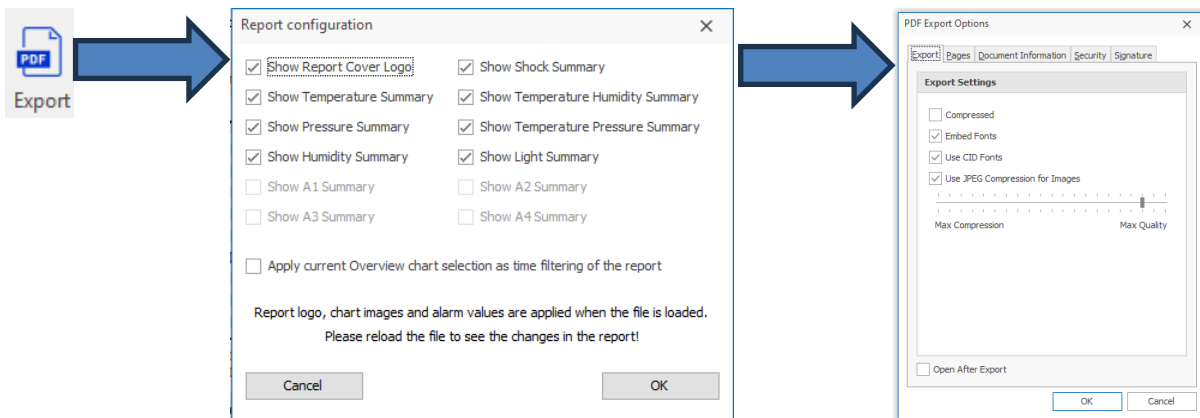

A flow diagram showing the export process. It starts with a PDF icon labeled "Export". An arrow points to a "Report configuration" dialog box with various checkboxes for report content. A second arrow points to a "PDF Export Options" dialog box with settings for compression, fonts, and image quality.

You may modify the export options according to your requirements. Click the 'OK' button and save the file. If you want to print the report, click the 'Print' icon. The printing configuration window provides you with tools to modify the page layout like changing the borders or adding a title and footnote. Click the 'Print' icon to print directly with your default printer or click the print with icon to select a printer of your choice.

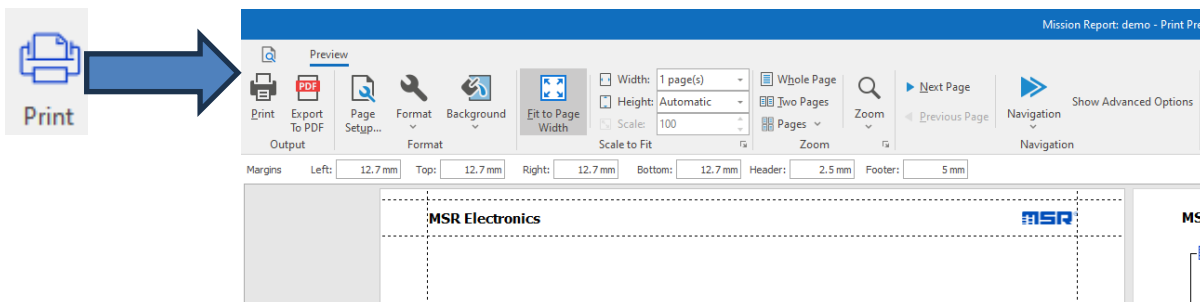

A screenshot of a printing configuration window titled "Mission Report: demo - Print Preview". It features a toolbar with icons for Print, Export To PDF, Page Setup, Format, Background, and Print Width. Below the toolbar are input fields for Margins (Left, Top, Right, Bottom), Header, and Footer. A preview area at the bottom shows the report header with "MSR Electronics" and the MSR logo.

6. Analyzing Shock Events and Sensor Recordings

6.1 The User Interface

The following provides a brief overview of the MSR165 ShockViewer user interface. As explained earlier, a shock report is displayed automatically when a data file is opened — this is known as the ‘Report’ view.

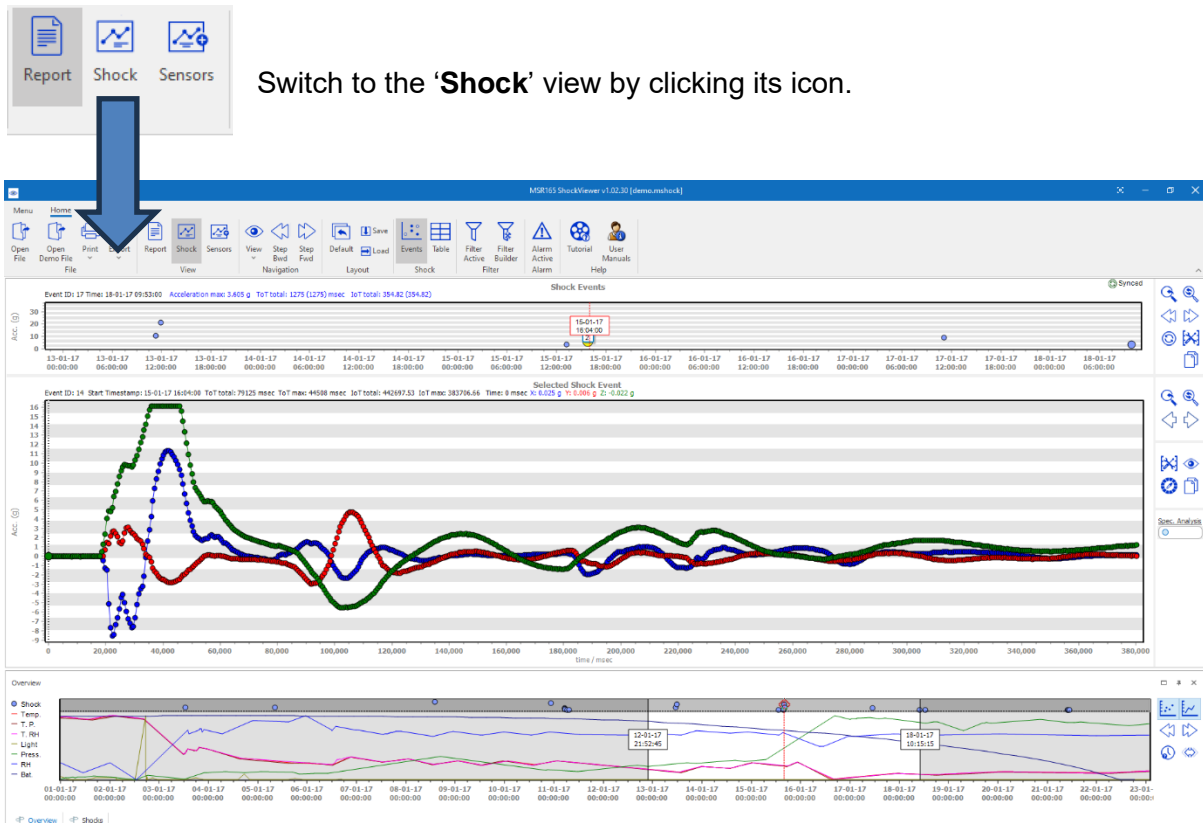

The ‘Shock’ view is the core of the MSR ShockViewer. It provides the tools needed to analyse shock events in detail.

The topmost of the three charts on the screen, called ‘Shock Events’, displays the shocks that occurred during the measurement period. Each **blue dot** represents a single shock event, while **yellow dots** indicate multiple events.

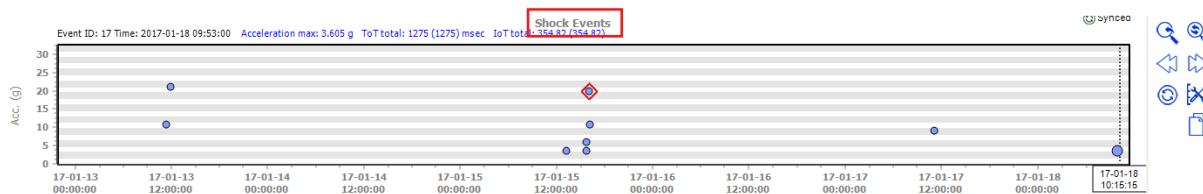

Click on one of the dots to select an event or use the arrows on the right to jump to the next event. The chart in the middle of the screen is called **'Selected Shock Events'** and it displays the measured curves of the selected event.

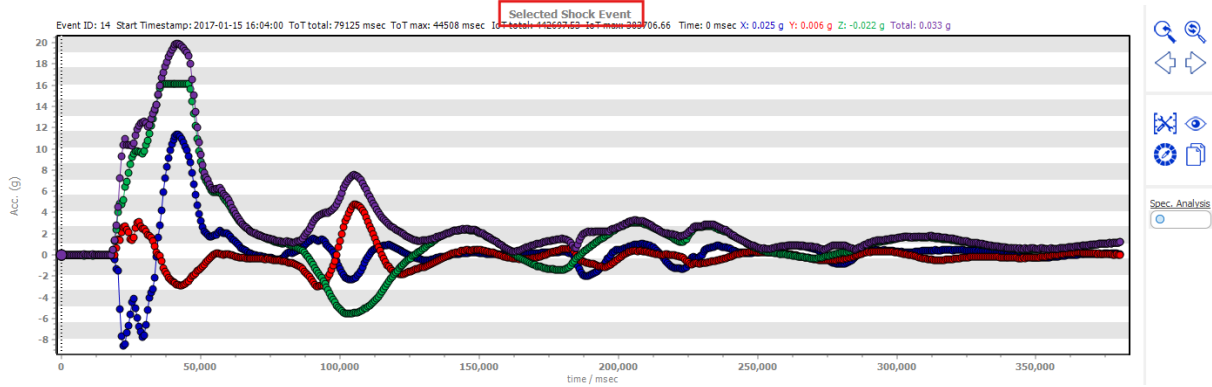

To show or hide **'Shock Events'** or **'Table'**, click on the icon.

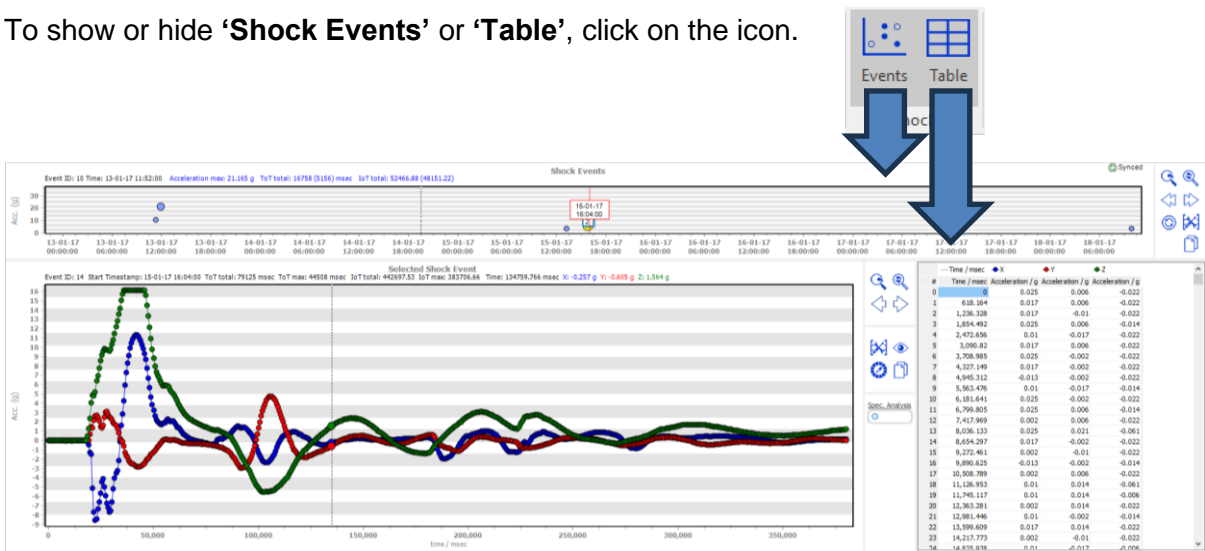

The lowest chart is the **'Overview'** chart. The Overview panel includes the **'Overview'** chart and a list of all **'Shocks'** events with data from other sensors, accessible via a separate tab.

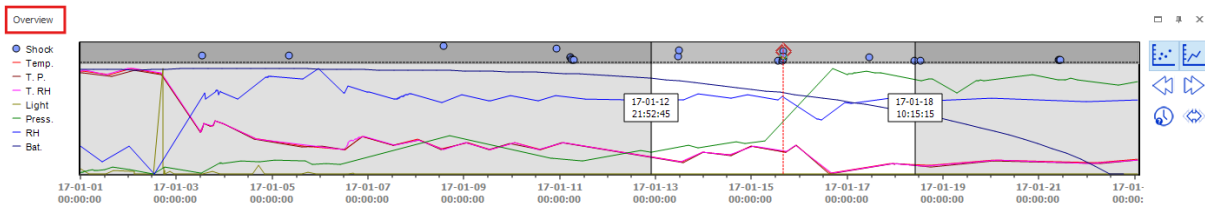

It's a great tool to navigate with all the data. It shows all measured curves by default and lets you select the time span to be displayed in the **'Shock Events'** chart by dragging the white block within the two date marks or by dragging the marks directly.

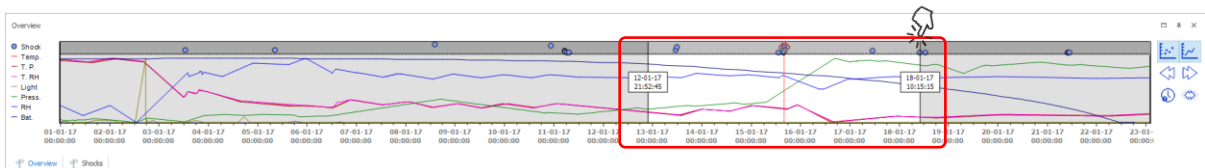

7. Setting Menus

7.1 Shock Event

You will find the settings menu to the right of the chart. You can synchronize the **'Shock Event'** with the **'Overview'**.

Copy Chart exports all highest values of each shock event in x-, y-, z-directions, and the resultant, in the selected wide of time window.

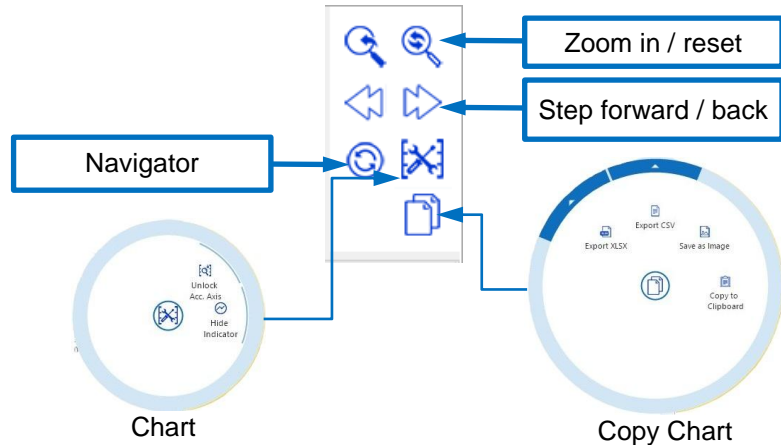

General notes for all menus:

- **'Lock Acc. Axis'** only allows zooming to the full height of the ordinate. **'Unlock Acc. Axis'** allows a customised zoom window.
- **'Hide Indicator'** and **'Show Indicator'** switch the value display (left above the chart) off and on respectively.

Selected Shock Event

Each graph in the chart can be displayed or removed and individual colors can be assigned. Switched off graphs are not displayed in the table on the right and are not exported.

The function **'Copy Chart'** export only the selected Shock event.

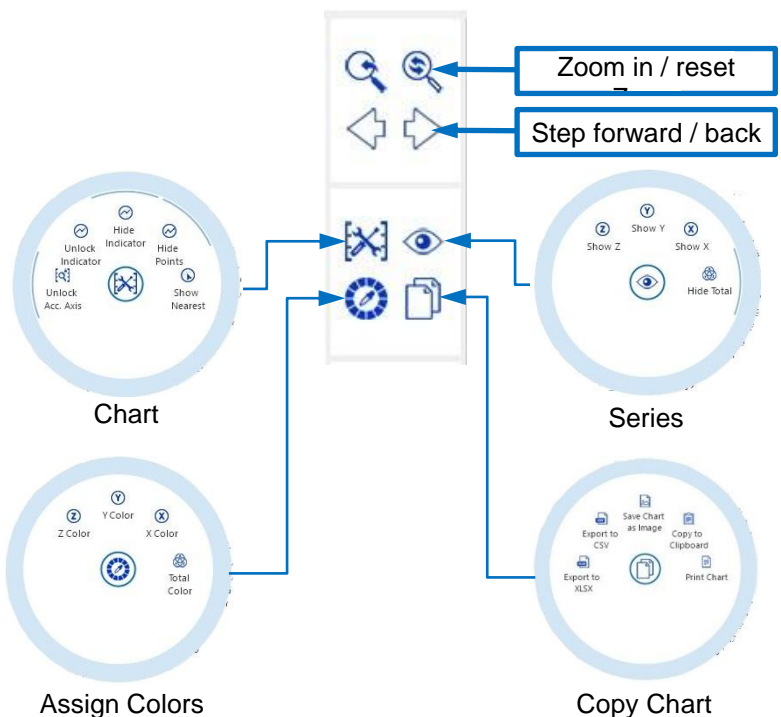

General note for this menu:

'Lock Indicator' shows the exact time for each measuring point. This function is switched off with **'Unlock Indicator'**.

The measuring points are displayed or switched off with **'Show Points'** or **'Hide Points'**.

Use **'Show Nearest'** to switch on the snap function for the measuring points.

'Lock Acc. Axis' / **'Unlock Acc. Axis'** and **'Show Indicator'** / **'Hide Indicator'** see general notes for all menus.

Overview

The **‘Overview’** serves as a summary of the entire measurement period and supports navigation through the recorded data. It consists of two separate display options: **‘Sensor Display’**, which shows the measurement curves of the various sensors, and **‘Shock Display’**, which visualizes the detected shock events. Both displays can be shown, or hidden by clicking the corresponding icons.

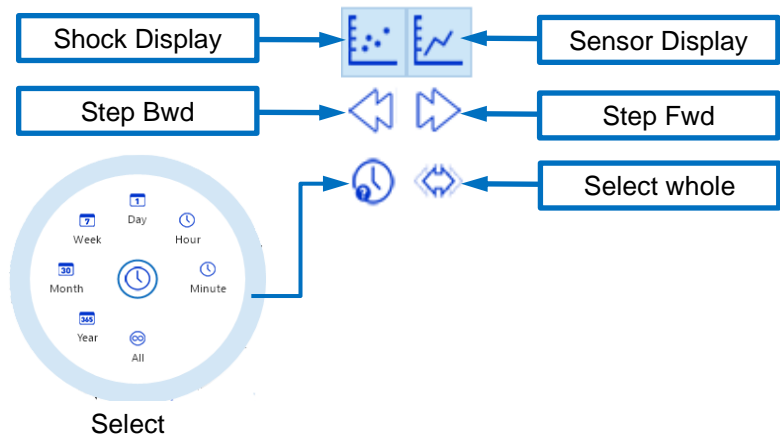

Sensor Overview

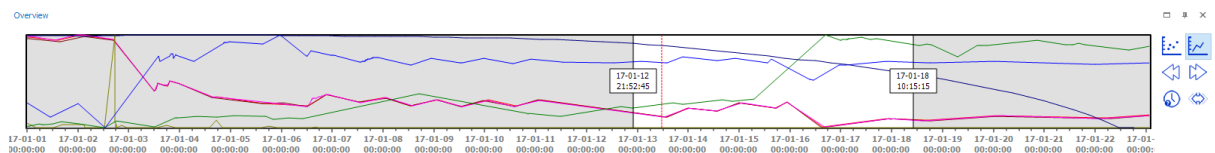

Shock Overview

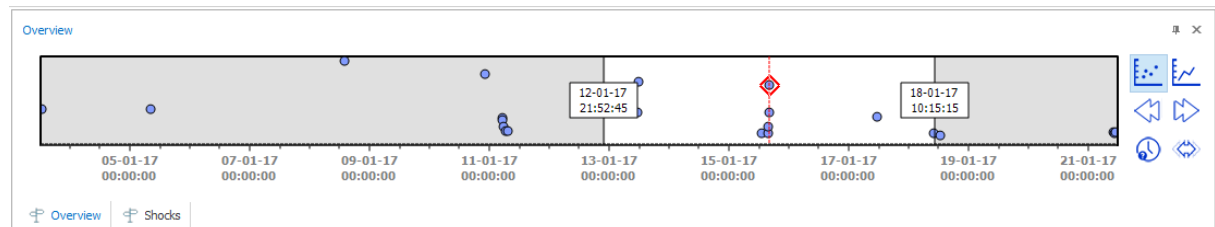

You can also use the buttons **‘Step Bwd’** / **‘Step Fwd’** on the right side to jump back and forth, select a fixed interval or switch between the entire measurement period and the last selected interval. In the upper icon menu **‘Navigation’**: **‘Show Shock’**, **Shock Overview’**, **‘Step Bwd’** and **‘Step Fwd’** are the similar functions.

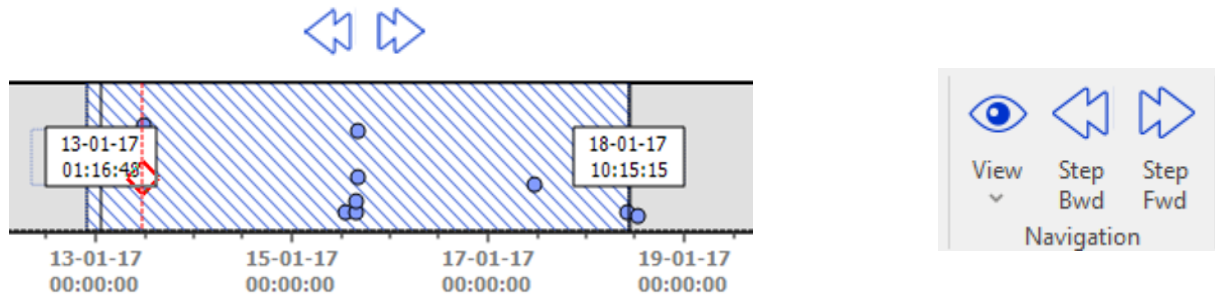

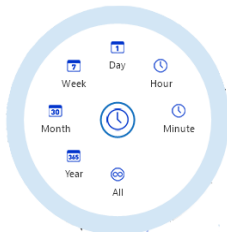

If you want to change the time span that is shown in the shock events chart, use the mouse to drag the whole section back or forth or to slide the delimiters.



The “Select Whole / Previous Timespan” switches to the entire time range of the measurement and back again.

8. Table 'Shocks'

Very important information is provided by the **'Shocks'** table, in which each stored event is initially listed independently of further processing and restriction by filters.

At the bottom left you will find the Shocks button. Click **'Overview'** to close the table again.

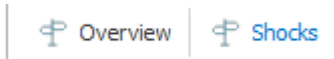

The table includes a sorting function. For example, click on the header of the **Events** column - such as **'Acceleration max'** - to sort the values in descending order. Click again to sort in ascending order.

ID	Timestamp	Acceleration max	ToT total	ToT max	IoT total	IoT max	Temp.	Temp. P	Temp. RH	Humidity	Dew Point	Light	Pressure	Battery
2	2017-01-08 14:02:00.	28.281	37439 msec	5164 msec	82710.1	62478.3	10.44 °C	10.4 °C	10.39	53.09 %RH	7.32 °C	0 lux	981.3 mbar	3.41 V
3	2017-01-10 22:22:00.	23.771	14510 msec	10094 msec	123520.89	86726.69	11.38 °C	11.4 °C	11.39	55.09 %RH	9.07 °C	0 lux	967 mbar	3.4 V
10	2017-01-13 11:52:00.	21.165	16758 msec	5156 msec	52466.88	48151.22	8.38 °C	8.3 °C	8.38	53.67 %RH	4.41 °C	0 lux	973.6 mbar	3.37 V
14	2017-01-15 16:04:00.	19.929	79125 msec	44508 msec	442697.53	383706.66	10.25 °C	10.2 °C	10.22	54.03 %RH	7.32 °C	0 lux	999.8 mbar	3.32 V
1	2017-01-05 08:17:00.	12.007	192423 msec	7079 msec	342159.75	27032.28	11.38 °C	11.3 °C	11.34	60.42 %RH	10.45 °C	0 lux	965.3 mbar	3.42 V
0	2017-01-03 12:43:00.	11.765	6113 msec	5502 msec	29613.63	29613.63	13.56 °C	13.5 °C	13.54	54.24 %RH	11.34 °C	0 lux	957.2 mbar	3.42 V
9	2017-01-13 11:19:00.	10.711	8750 msec	6250 msec	30695.47	29251.32	8.44 °C	8.3 °C	8.41	53.68 %RH	4.52 °C	0 lux	973.5 mbar	3.37 V
15	2017-01-15 16:11:00.	10.711	8750 msec	6250 msec	30695.47	29251.32	10.25 °C	10.2 °C	10.18	53.9 %RH	7.28 °C	0 lux	999.9 mbar	3.32 V

Danger signs indicate that limits have been exceeded or undercut. By selecting a row in this table, the corresponding shock event is displayed in the **'Selected Shock Event'** chart.

ID	Timestamp	Acceleration max	ToT total	ToT max	IoT total	IoT max	Temp.	Temp. P	Temp. RH	Humidity	Dew Point	Light	Pressure	Battery
2	2017-01-08 14:02:00.	28.281	37439 msec	5164 msec	82710.1	62478.3	10.44 °C	10.4 °C	10.39	53.09 %RH	7.32 °C	0 lux	981.3 mbar	3.41 V
3	2017-01-10 22:22:00.	23.771	14510 msec	10094 msec	123520.89	86726.69	11.38 °C	11.4 °C	11.39	55.09 %RH	9.07 °C	0 lux	967 mbar	3.4 V
10	2017-01-13 11:52:00.	21.165	16758 msec	5156 msec	52466.88	48151.22	8.38 °C	8.3 °C	8.38	53.67 %RH	4.41 °C	0 lux	973.6 mbar	3.37 V
14	2017-01-15 16:04:00.	19.929	79125 msec	44508 msec	442697.53	383706.66	10.25 °C	10.2 °C	10.22	54.03 %RH	7.32 °C	0 lux	999.8 mbar	3.32 V
1	2017-01-05 08:17:00.	12.007	192423 msec	7079 msec	342159.75	27032.28	11.38 °C	11.3 °C	11.34	60.42 %RH	10.45 °C	0 lux	965.3 mbar	3.42 V
0	2017-01-03 12:43:00.	11.765	6113 msec	5502 msec	29613.63	29613.63	13.56 °C	13.5 °C	13.54	54.24 %RH	11.34 °C	0 lux	957.2 mbar	3.42 V
9	2017-01-13 11:19:00.	10.711	8750 msec	6250 msec	30695.47	29251.32	8.44 °C	8.3 °C	8.41	53.68 %RH	4.52 °C	0 lux	973.5 mbar	3.37 V
15	2017-01-15 16:11:00.	10.711	8750 msec	6250 msec	30695.47	29251.32	10.25 °C	10.2 °C	10.18	53.9 %RH	7.28 °C	0 lux	999.9 mbar	3.32 V

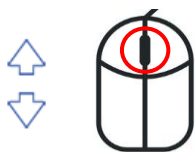
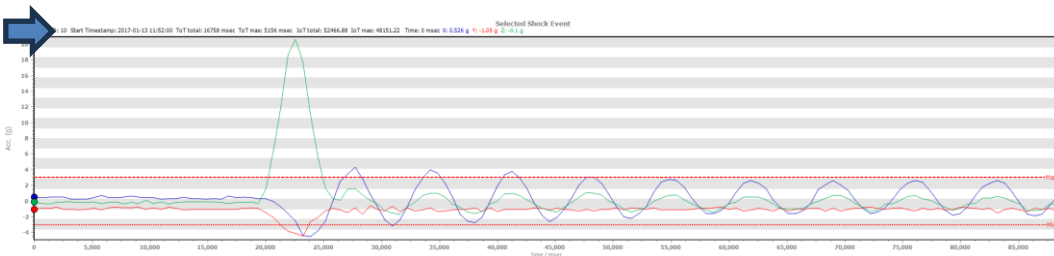

To select a row, click on the row with the right mouse button, jump to the next row using the arrows to the right of the table, or turn the center mouse wheel to scroll up or down.

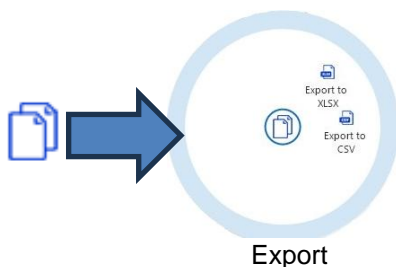

Use **'Export Table'** to transfer the table to an Excel or CSV format.

9. Sensor Chart

Click on the **'Sensors'** icon on **'View'** group to open the third view, the **'Sensors'** view. If your data logger is equipped with other sensors such as temperature or humidity, their measurements can be found here. The area reserved for the measured curves called **'Sensors'** is empty by default.

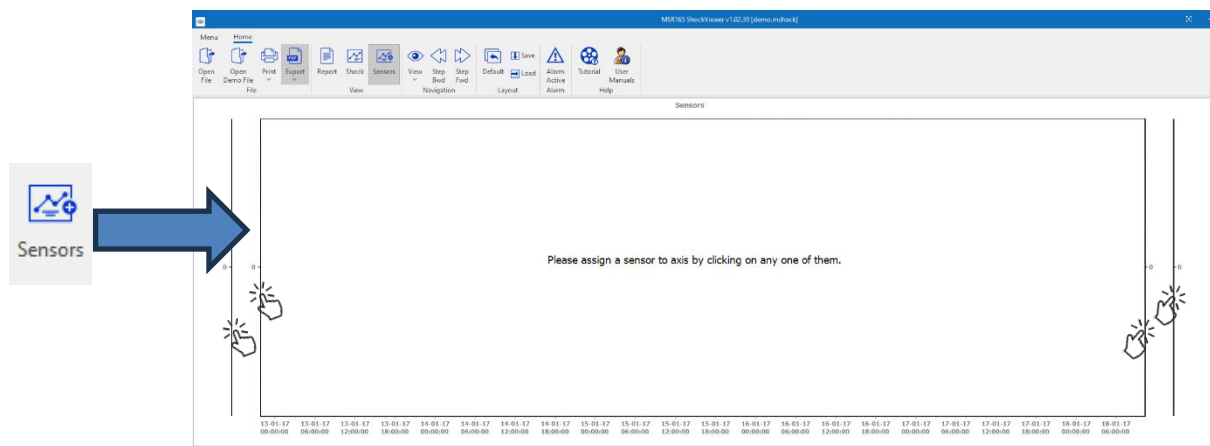

To display sensor data, click on one of the vertical axes (see above) or use the 4 axis icons to assign a sensor type.



The selection wheel appears in both cases. Select a sensor and go to the next axis to add another sensor.

With **'None'** you can remove the selected sensor from the chart. Only the sensors that were activated in the data logger when the order was placed can be selected.

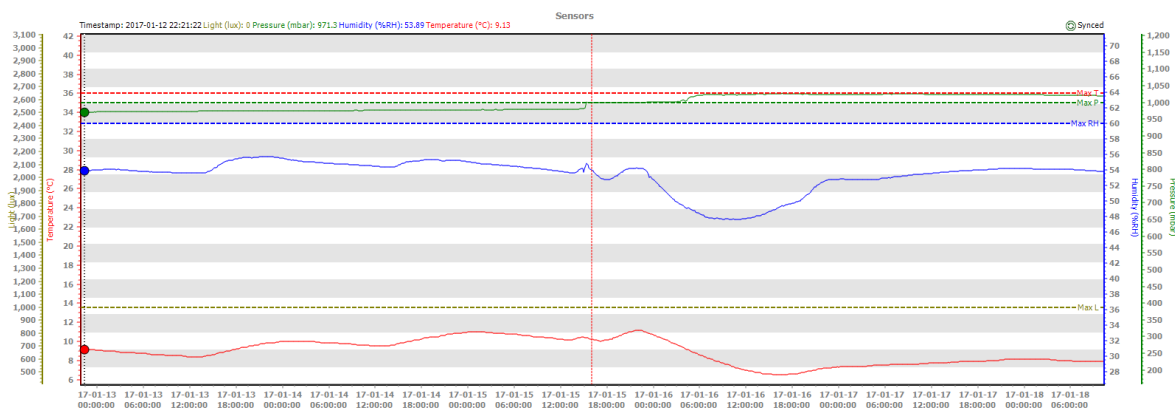

Each sensor has its own scaling according to its measuring range. A total of 4 external sensors can be added.

You may again use the navigator in the lower part of the window to navigate through the measurement period and select the time span to be displayed, or...

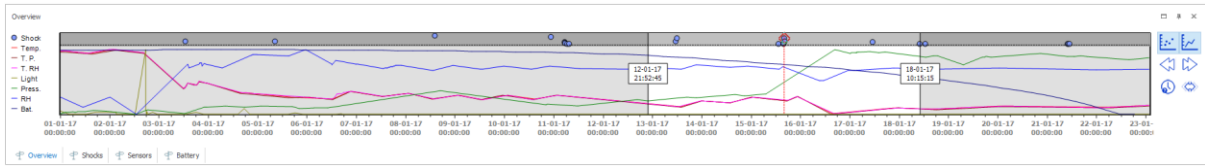

selecting an event in the “Shocks” table or a point in the ‘Shock Event’ chart shows you the time of the event in the sensor chart with a red line.

Shocks

ID	Timestamp	Acceleration max	ToT total	ToT max	IoT total	IoT max	Temp.	Temp. P	Temp. RH	Humidity	Dew Point	Light	Pressure	Battery
16	2017-01-17 11:04:00. ⚠	9.198	60303 msec	4443 msec	71338.11	12211.82	7.69 °C	7.5 °C	7.66 °C	53.51 %RH	3.19 °C	0 lux	1025.2 mbar	3.27 V
13	2017-01-15 15:47:00. ⚠	5.908	26306 msec	3850 msec	19784.17	5771.75	10.25 °C	10.2 °C	10.26 °C	54.15 %RH	7.35 °C	0 lux	999.8 mbar	3.32 V
10	2017-01-13 11:52:00. ⚠	21.165	16758 msec	5156 msec	52466.88	48151.22	8.38 °C	8.3 °C	8.38 °C	53.67 %RH	4.41 °C	0 lux	973.6 mbar	3.37 V
15	2017-01-15 16:11:00. ⚠	10.711	8750 msec	6250 msec	30695.47	29251.32	10.25 °C	10.2 °C	10.18 °C	53.9 %RH	7.28 °C	0 lux	999.9 mbar	3.32 V
9	2017-01-13 11:19:00. ⚠	10.711	8750 msec	6250 msec	30695.47	29251.32	8.44 °C	8.3 °C	8.41 °C	53.68 %RH	4.52 °C	0 lux	973.5 mbar	3.37 V
11	2017-01-15 13:12:00. ⚠	3.634	3198 msec	1919 msec	882.49	882.49	10.13 °C	10.1 °C	10.14 °C	53.69 %RH	7.06 °C	0 lux	980.4 mbar	3.32 V
17	2017-01-18 09:53:00. ⚠	3.605	1275 msec	1275 msec	354.82	354.82	7.88 °C	7.7 °C	7.82 °C	53.83 %RH	3.61 °C	0 lux	1020.3 mbar	3.23 V

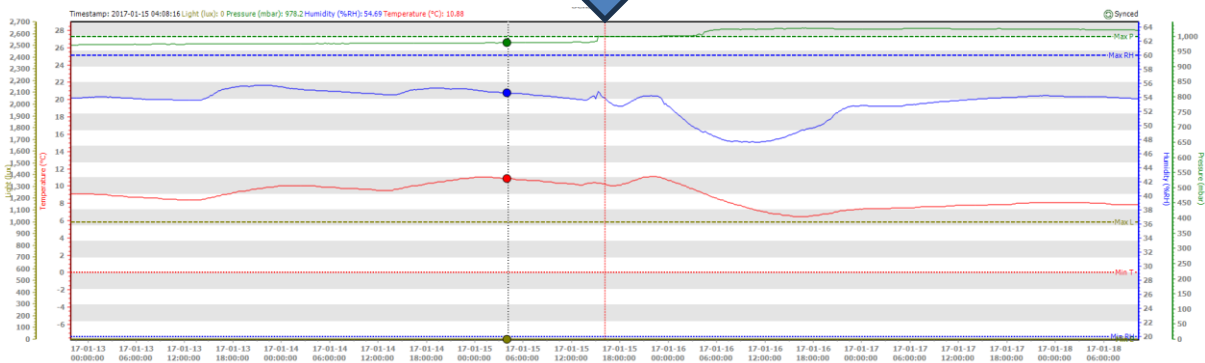

As soon as you switch from Shocks to Sensor, the tables for sensors and the battery appear at the bottom left.

Sensors

ID	Timestamp	Temp.	Temp. P	Temp. RH	Humidity	Dew Point	Pressure	Light
1716	2017-01-12 22:00:00.	9.13 °C	9.1 °C	9.08 °C	53.89 %RH	5.66 °C	971.4 mbar	0 lux
1717	2017-01-12 22:10:00.	9.13 °C	9.1 °C	9.09 °C	53.89 %RH	5.66 °C	971.3 mbar	0 lux
1718	2017-01-12 22:20:00.	9.13 °C	9 °C	9.08 °C	53.89 %RH	5.66 °C	971.3 mbar	0 lux
1719	2017-01-12 22:30:00.	9.13 °C	9.1 °C	9.08 °C	53.92 %RH	5.67 °C	971.4 mbar	0 lux
1720	2017-01-12 22:40:00.	9.13 °C	9 °C	9.08 °C	53.95 %RH	5.68 °C	971.3 mbar	0 lux
1721	2017-01-12 22:50:00.	9.13 °C	9 °C	9.08 °C	53.95 %RH	5.68 °C	971.5 mbar	0 lux
1722	2017-01-12 23:00:00.	9.13 °C	9 °C	9.09 °C	53.95 %RH	5.68 °C	971.6 mbar	0 lux
1723	2017-01-12 23:10:00.	9.13 °C	9 °C	9.07 °C	53.95 %RH	5.68 °C	971.6 mbar	0 lux

Battery

ID	Timestamp	Battery
40	2017-01-12 22:02:00.	3.38 V
41	2017-01-13 05:11:00.	3.37 V
42	2017-01-13 12:21:00.	3.37 V
43	2017-01-13 19:31:00.	3.36 V
44	2017-01-14 02:41:00.	3.36 V
45	2017-01-14 09:51:00.	3.35 V
46	2017-01-14 17:01:00.	3.34 V
47	2017-01-15 00:11:00.	3.33 V

10. Filter and Filter Builder

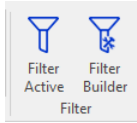

The **Filter** function in ShockViewer allows you to separate relevant measurement data from less important or unwanted data. You can use Boolean operators in the **'Filter Builder'** to mathematically define limits, thresholds, and value ranges. The **'Filter Active'** and **'Filter Builder'** functions are explained in more detail below using an example. To view the full mission, expand the **'Overview'** section.

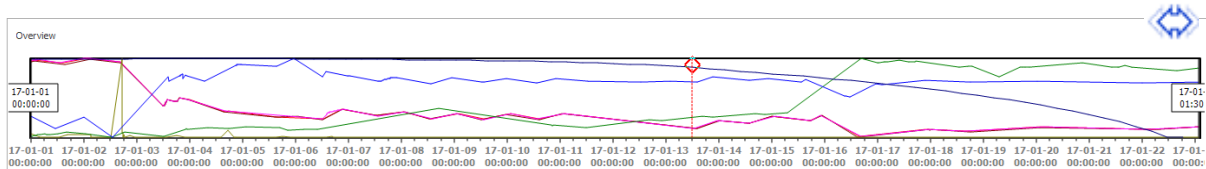

Open the **'Shocks'** table.

ID	Timestamp	Acceleration max	ToT total	ToT max	IsT total	IsT max	Temp.	Temp. P	Temp. RH	Humidity	Dew Point	Light	Pressure	Battery
0	03-01-17 12:43:00.0	11.765	6113 msec	5502 msec	29613.63	29613.63	13.56 °C	13.5	13.54	54.24 %RH	11.34 g	957.2 mbar	3.42V	
1	05-01-17 08:17:00.0	10.097	160423 msec	7079 msec	302156.75	27832.28	11.38 °C	11.3	11.34	50.42 %RH	10.45 g	965.3 mbar	3.42V	
2	08-01-17 14:52:00.0	26.281	37439 msec	5164 msec	82735.1	62478.2	10.44 °C	10.4	10.39	53.09 %RH	7.32 g	961.3 mbar	3.41V	
3	10-01-17 22:22:00.0	23.771	14510 msec	10094 msec	123520.89	88726.69	11.38 °C	11.4	11.39	55.09 %RH	9.07 g	967 mbar	3.4V	
4	11-01-17 05:16:00.0	8.815	18656 msec	7049 msec	30023.41	19727.29	11.25 °C	11.2	11.24	54.56 %RH	8.77 g	966.5 mbar	3.4V	
5	11-01-17 05:21:00.0	8.211	15335 msec	3828 msec	20993.61	7941.46	11.25 °C	11.2	11.24	54.56 %RH	8.77 g	966.5 mbar	3.4V	
6	11-01-17 05:37:00.0	5.985	153810 msec	2574 msec	106677.27	3676.14	11.25 °C	11.2	11.22	54.53 %RH	8.77 g	966.4 mbar	3.4V	
7	11-01-17 06:22:00.0	4.473	5070 msec	2535 msec	1615.23	860.62	11.13 °C	11.1	11.16	54.49 %RH	8.6 g	966.1 mbar	3.4V	
8	11-01-17 07:13:00.0	4.309	5180 msec	1242 msec	1896.70	932.8	11.13 °C	11.1	11.1	54.42 %RH	8.59 g	966.1 mbar	3.4V	

Now drag or place the **'Shocks'** table on the left-hand side of the main window.

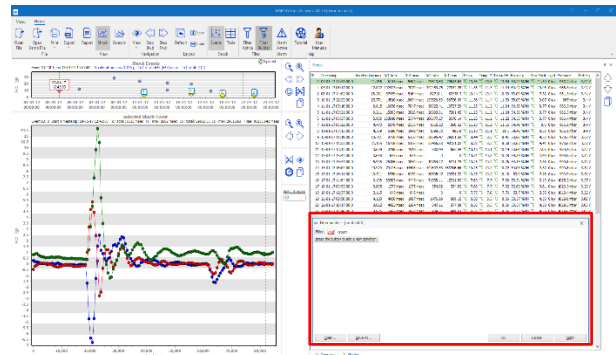
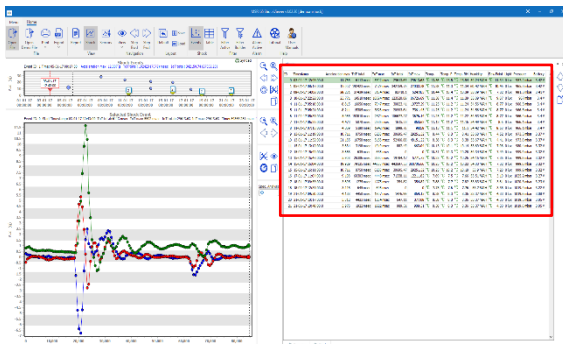

Open the **'Filter Builder'** by clicking on its icon in the filter group of the command bar (see above). The first criterion is shock events over $\pm 10g$. To define this filter criteria, add a condition to the filter builder by either pressing the wide self-explanatory button **'Press the button to add a new condition'** or by clicking on **'Filter'** and selecting **'Add Condition'**.

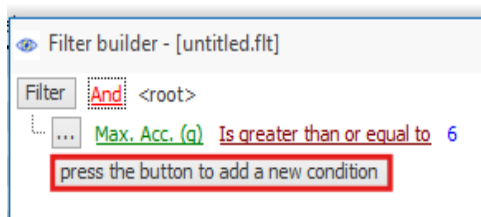

OR

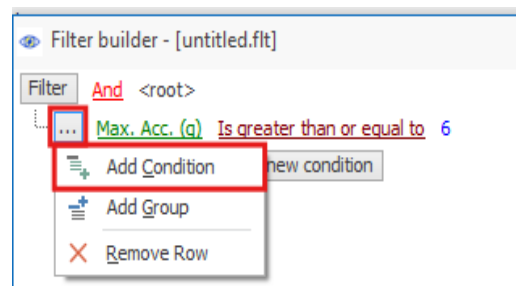

A new row is added, containing the unit to be filtered, an **Operator** field initially set to **Equals**, and a placeholder labelled **<empty>** for the value. To complete the example, click on **Equals** and select **Is greater than or equal to** from the dropdown menu.

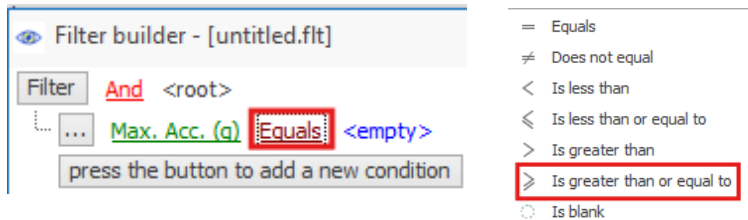

Then click on the **'<empty>'** placeholder and write **'10'**. You have now created a simple filter. Click the **'OK'** button to apply the filter and close the filter builder.

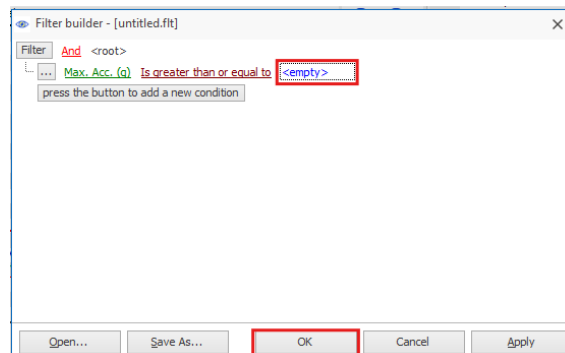

The **'Shock Events'** chart as well as the **'Shocks'** panel only display the shocks fulfilling the filter criteria. The applied criteria are shown in the title bar of the **'Shocks'** panel. The **'Filter Active'** icon in the command bar is selected which means that filtering is applied.

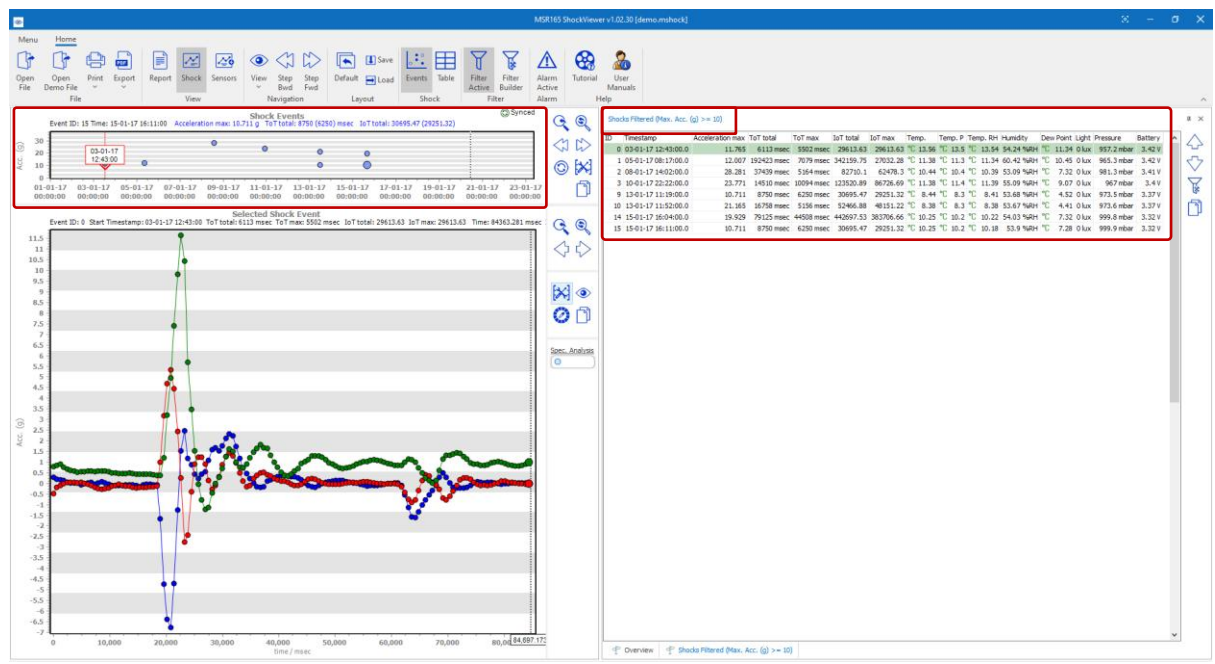

Let's reapply the filter by again clicking on the 'Filter Active' icon. Open the 'Filter Builder' again. Let's add the criterion **ToT max** of minimum **'7,000'** or an **IoT max** of minimum **'50,000'**.

The 10g condition is already set in the filter builder. To add the two other conditions, we need to add a new group of conditions within which the conditions are evaluated with and or operator.

To do so, start by clicking on the 'Second Node'  and choose 'Add Group'. A third node is added that represents a group of conditions and a fourth node that represents the first condition of this group. Click on the 'And' operator of the third line and change it to 'Or' since that's the correct operator to apply to the conditions of the following group.

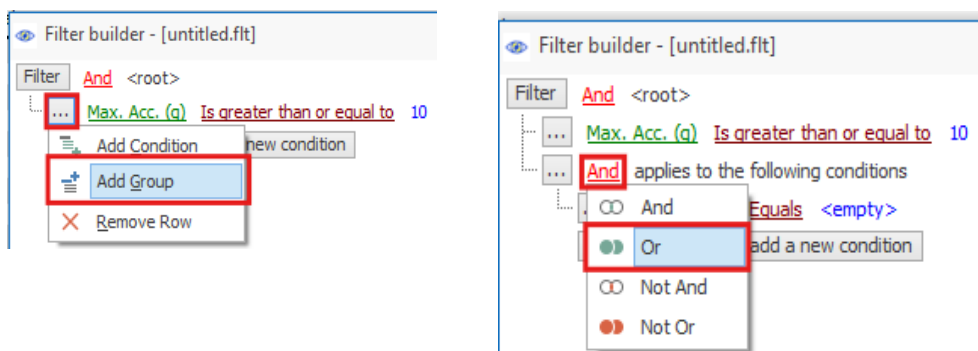

Then define the condition for the **ToT max** value, click on 'Equals' and select 'Is greater than or equal to'. Then click on the '<empty>' place holder and write **'7000'**. Click the 'Apply' button to check whether the filter works so far.

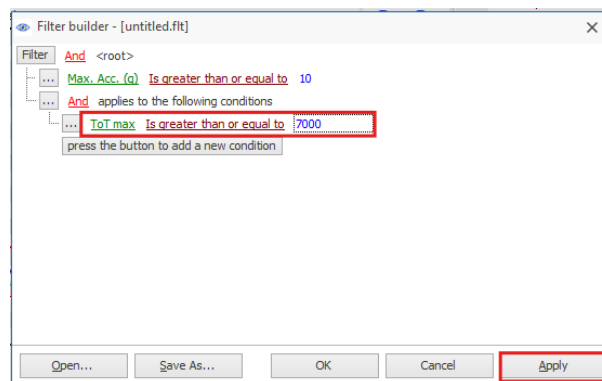

Add a new condition for the **IoT** criteria by clicking 'press the button to add a new condition'.

Then define the condition for the **IoT max** value, click on 'Equals' and select 'Is greater than or equal to'. Then click on the '<empty>' place holder and write **'50000'**. Finally, click the 'Apply' button to check whether the filter works so far.

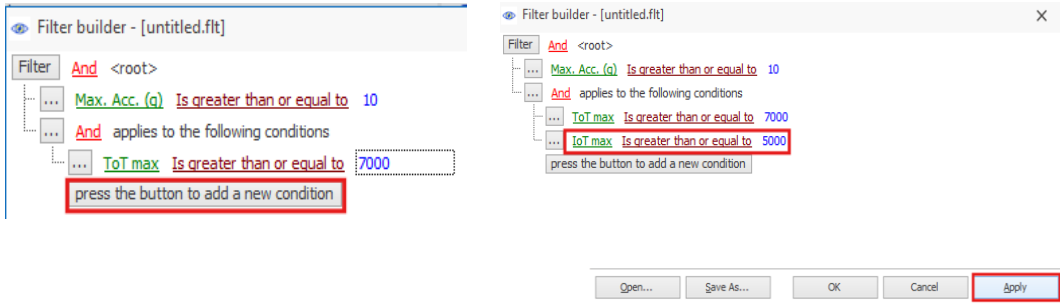

The 'Shock Events' chart as well as the 'Shocks' panel only displays the shocks fulfilling the filter criteria. The applied criteria is shown in the title bar of the 'Shocks' panel. The 'Filter Active' icon in the command bar is selected which means that filtering is applied.

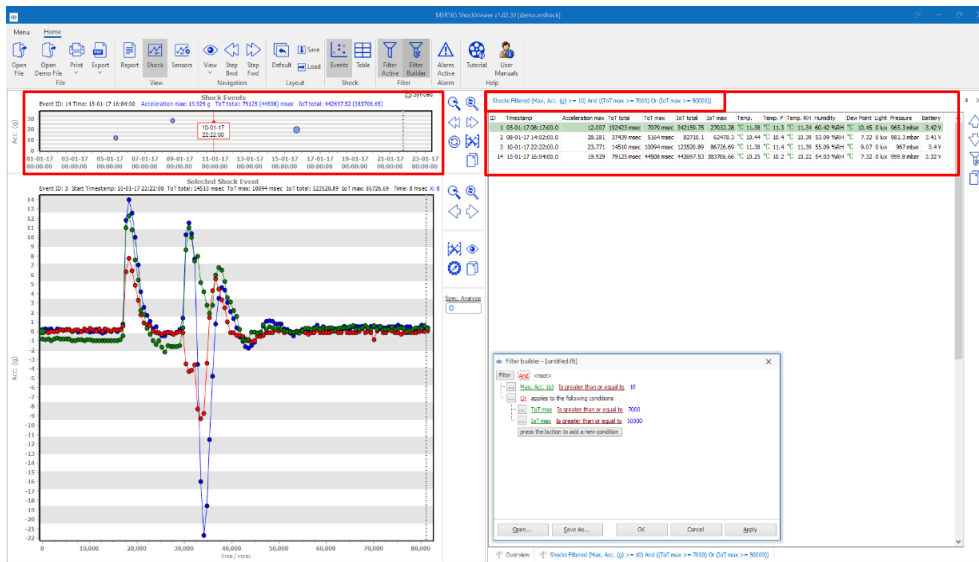

After becoming familiar with the Filter Builder, creating filters is quick and easy. Note that you may save your filters for later use by clicking the 'Save As' button in the 'Filter Builder'.

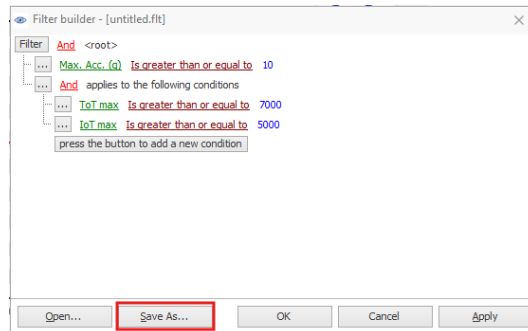

It is important to know that filtering not only applies to the data you see in the application but also to the data export that's accessible via the export icon on the command bar.

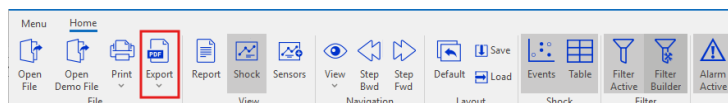

11. Alarm Active

The **'Alarm Active'** view shows the set threshold values, which can be modified in the input fields. Please note that these changes do not affect the calculations for **IoT**, **ToT**, or shock detection — these are based solely on the original thresholds.

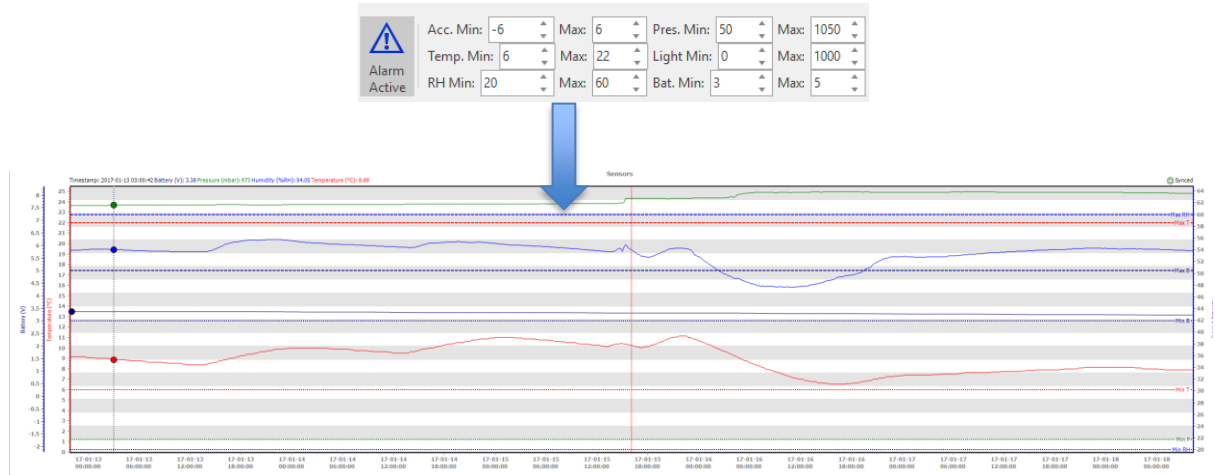

12. Customize MSR165 ShockViewer

Customize the MSR165 ShockViewer for your needs. With “Collapse the Ribbon” you can hide the icon menu.

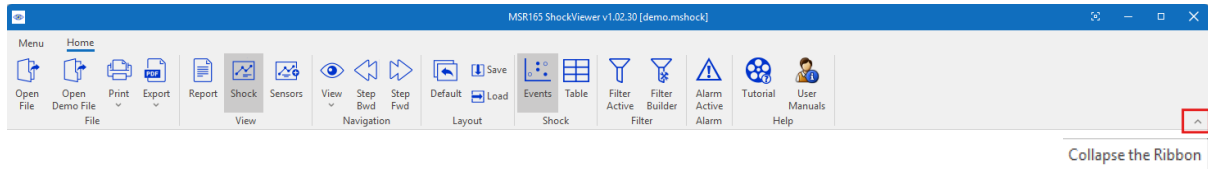

A click on the ‘**Home**’ tab will bring it back but it will hide again as soon as you click on an item. To bring it back to its fixed position click on the small arrow ‘**Rib the Ribbon**’ that is accessible when the toolbar is opened.

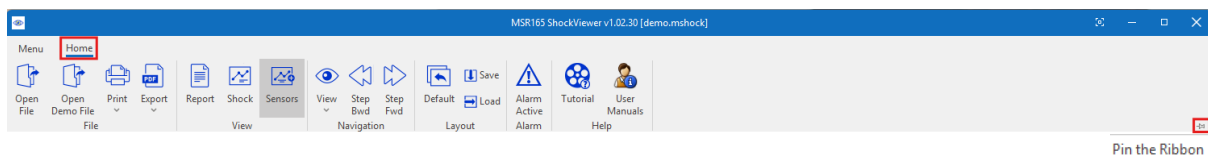

The same options are also available via the ‘**Ribbon Configuration**’ menu, located in the upper right corner of the window. ‘**Show Tabs and Commands**’ is the default.

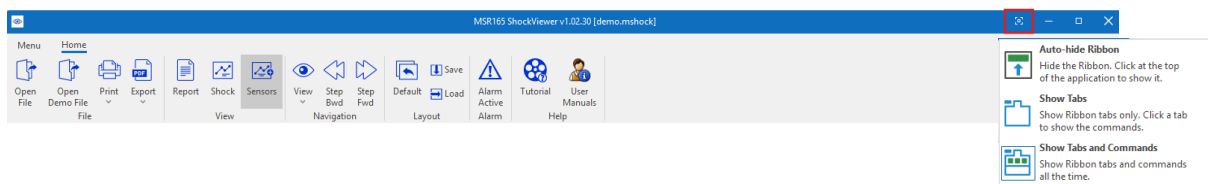

‘**Show Tabs and Commands**’ is the default behaviour with a fixed command bar while ‘**Show Tabs**’ corresponds to the hiding behaviour. If you want to hide the command bar including the tabs, choose the option ‘**Auto-hide Ribbon**’. Note that the word ribbon refers to the band where the tabs are located.

You will find even more flexibility with the ‘**Overview**’ panel: You may grab it...

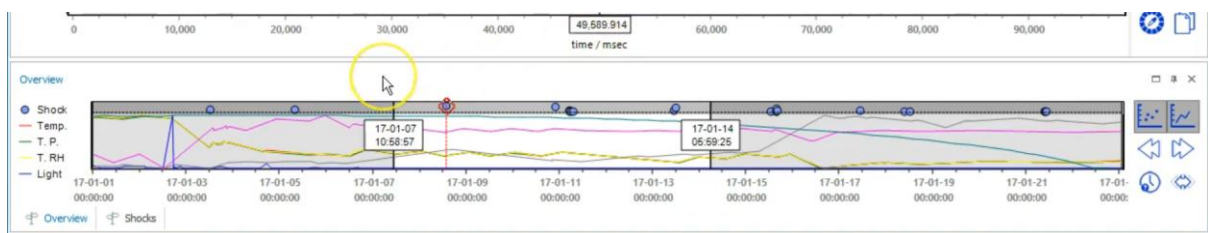

and drag it to any position of your screen.

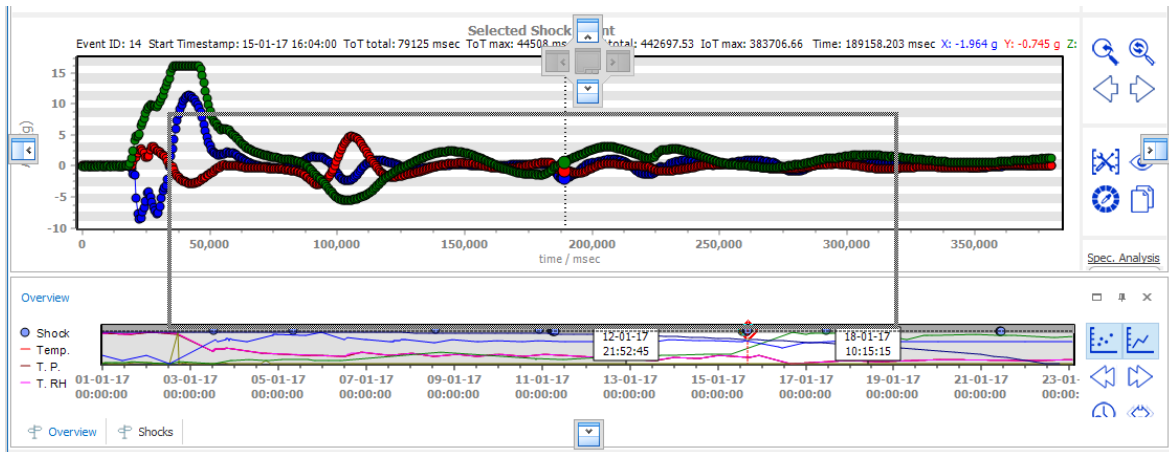

You can also move the panel outside the main program window. If you want to pin it to a specific side, simply drag it over one of the positioning symbols that appear.

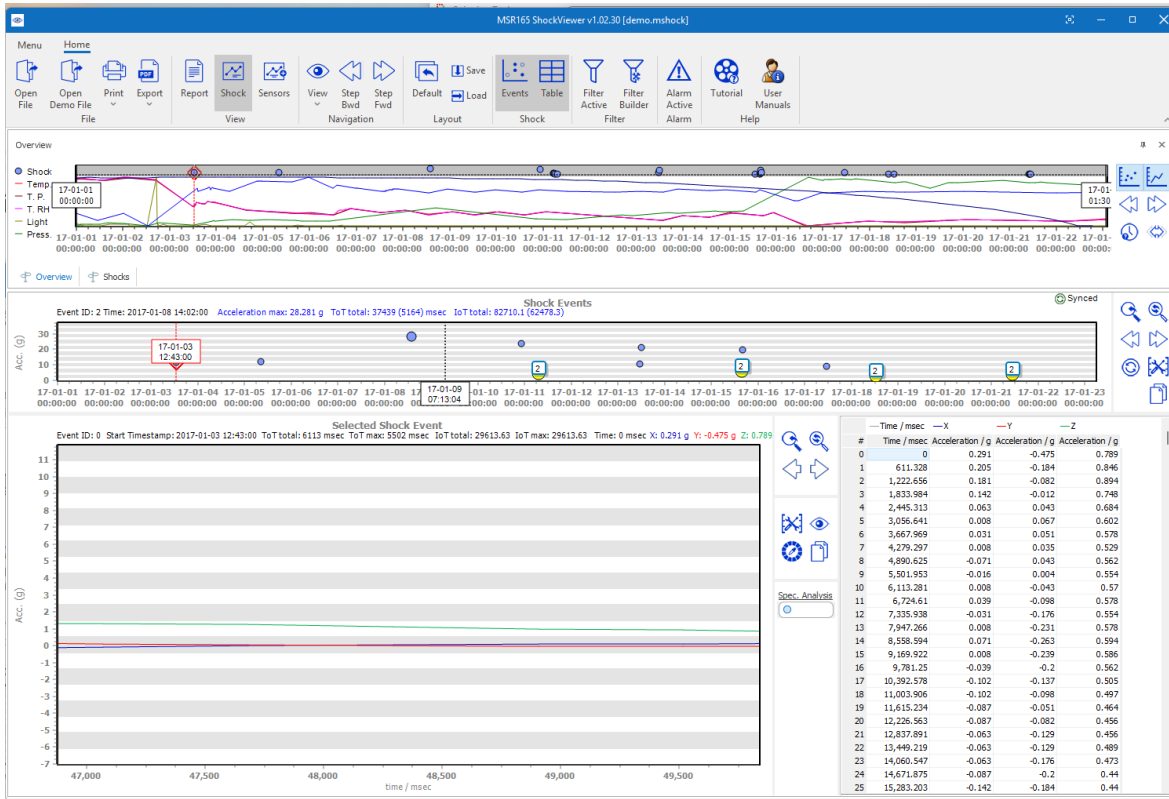

'Save' in the layout group of the command bar to save the position of the navigator window.



Default

You can use the 'Default' icon to restore the default configuration of the window at any time.



You can use the 'Load' icon to restore the last saved configuration.

13. Spectral Analysis

13.1 Magnitude FFT

The ShockViewer includes the spectral analysis / derivation of the time signal. Open '**Spec. Analysis**' by dragging the slider to the right.

First sort the '**Shocks**' table and select the first "extraordinary" event.

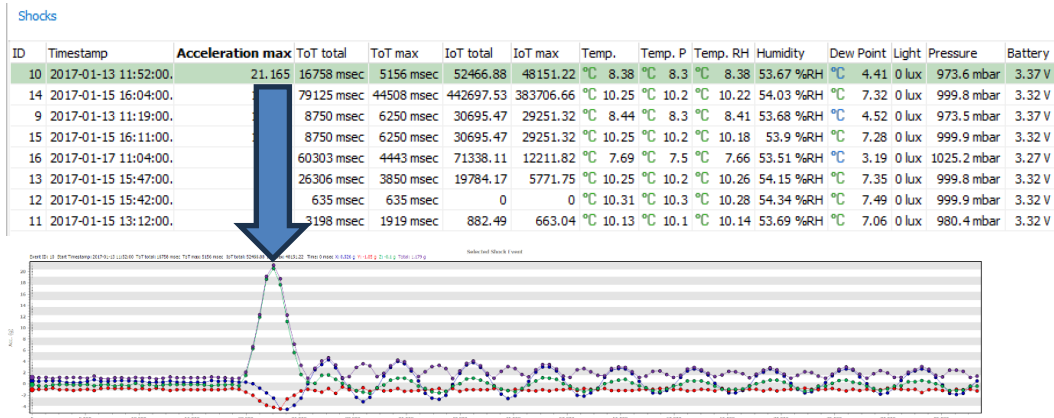

Move the slider from '**Spec. Analysis**' to the right – the background turns blue. Then select the '**Spectrum Type**' – '**Magnitude**' and '**Weighting Win.** – '**Rectangle**'.

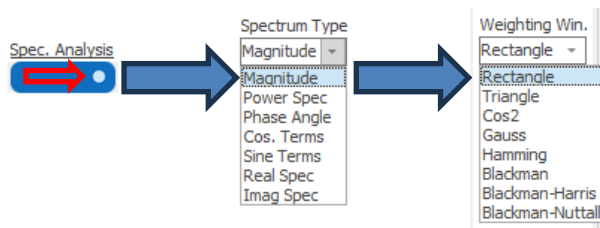

You will see now in the chart the '**Magnitude FFT**', depending on the setting of the displayed axis with acceleration max., X-, Y- and Z-axis.

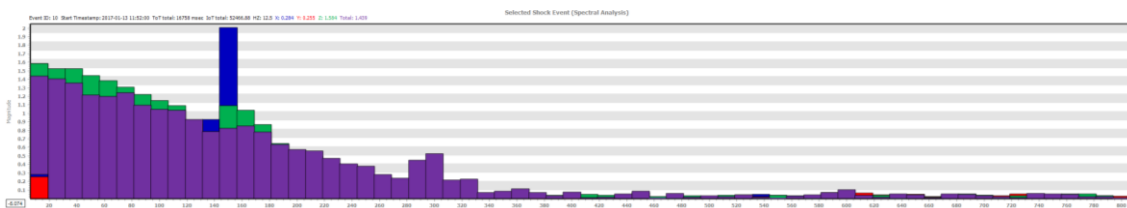

With '**Series Visibility**' you can now hide or show the display of the individual axes.

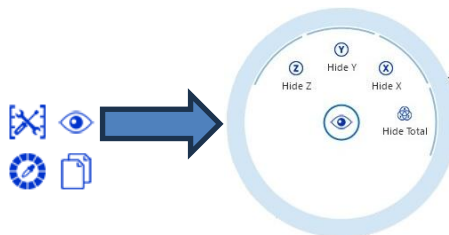

First isolate the magnitude of '**Acceleration max**'. This already has the absolute value that it is the square root of the squares of the axes.

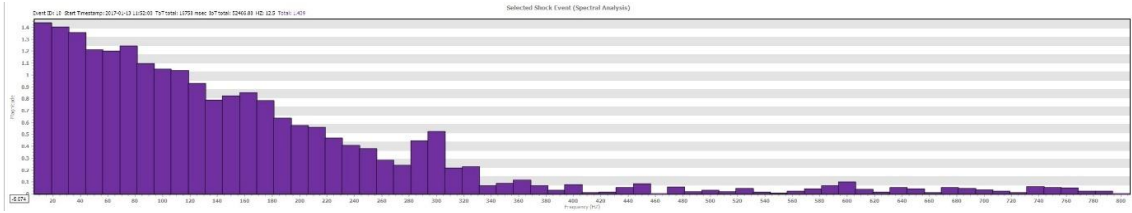

Then fade in the individual axis and display the different accelerations of the axis in the spectrum. The magnitude always shows the absolute value of the acceleration:

$$y = abs(fft(u, nfft))$$

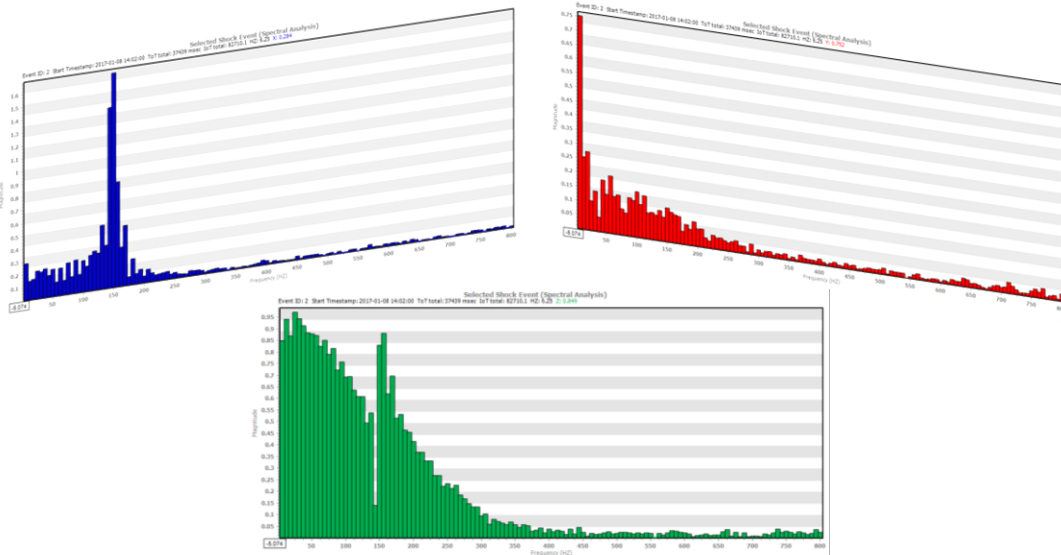

By adding the '**Table**' icon, this appears to the right of the chart. Table values can be exported in the same way as the measurement data. To do this, use the '**Copy Chart**' icon.

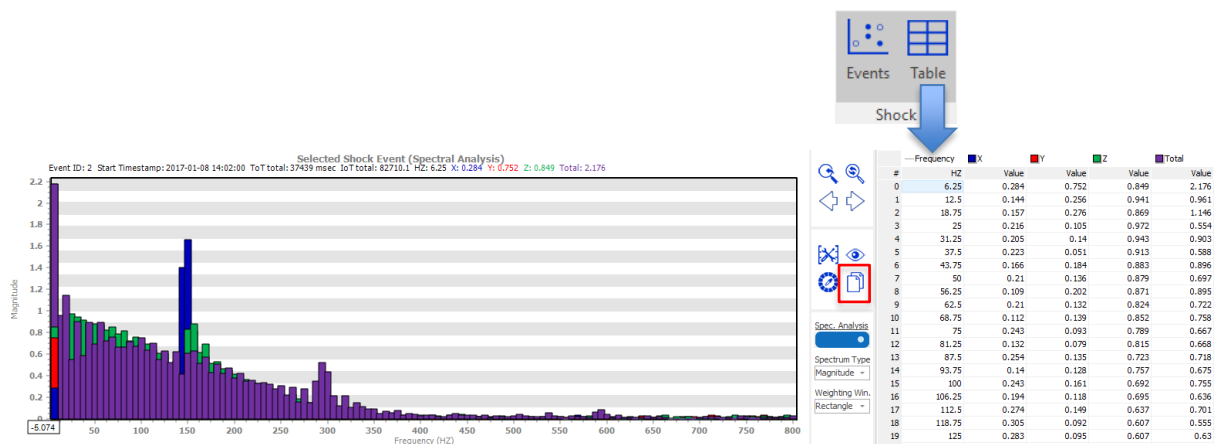

To view a different spectral analysis, scroll to the next shock event in the **'Shocks'** table. Of course, you can drag the slider to the left in the new event to view the time-dependent shock recording.

Shocks

ID	Timestamp	Acceleration max	ToT total	ToT max	IoT total	IoT max	Temp.	Temp. P	Temp. RH	Humidity	Dew Point	Light	Pressure	Battery
10	2017-01-13 11:52:00.	21.165	16758 msec	5156 msec	52466.88	48151.22	°C 8.38	°C 8.3	°C 8.38	53.67 %RH	°C 4.41	0 lux	973.6 mbar	3.37 V
14	2017-01-15 16:04:00.	19.929	79125 msec	44508 msec	442697.53	383706.66	°C 10.25	°C 10.2	°C 10.22	54.03 %RH	°C 7.32	0 lux	999.8 mbar	3.32 V
9	2017-01-13 11:19:00.	10.711	8750 msec	6250 msec	30695.47	29251.32	°C 8.44	°C 8.3	°C 8.41	53.68 %RH	°C 4.52	0 lux	973.5 mbar	3.37 V
15	2017-01-15 16:11:00.	10.711	8750 msec	6250 msec	30695.47	29251.32	°C 10.25	°C 10.2	°C 10.18	53.9 %RH	°C 7.28	0 lux	999.9 mbar	3.32 V
16	2017-01-17 11:04:00.	9.198	60303 msec	4443 msec	71338.11	12211.82	°C 7.69	°C 7.5	°C 7.66	53.51 %RH	°C 3.19	0 lux	1025.2 mbar	3.27 V
13	2017-01-15 15:47:00.	5.908	26306 msec	3850 msec	19784.17	5771.17	°C 10.25	°C 10.2	°C 10.26	54.15 %RH	°C 7.35	0 lux	999.8 mbar	3.32 V
12	2017-01-15 15:42:00.	3.658	635 msec	635 msec	0	0	°C 10.31	°C 10.3	°C 10.28	54.34 %RH	°C 7.49	0 lux	999.9 mbar	3.32 V
11	2017-01-15 13:12:00.	3.634	3198 msec	1919 msec	882.49	663.49	°C 10.13	°C 10.1	°C 10.14	53.69 %RH	°C 7.06	0 lux	980.4 mbar	3.32 V

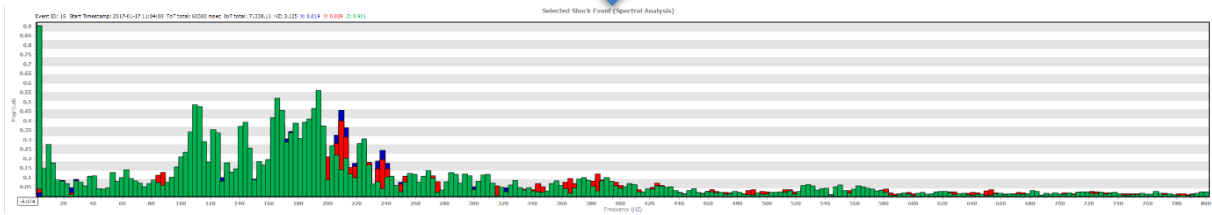
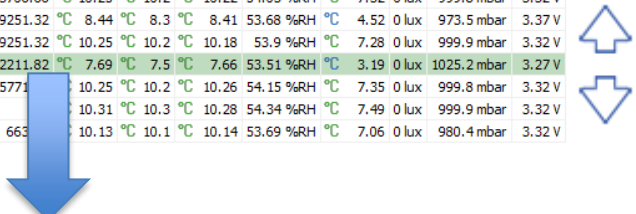

By moving the **'Spec. Analysis'** slider, the time-dependent measurement data of the shock event previously displayed as a spectral analysis is displayed again.

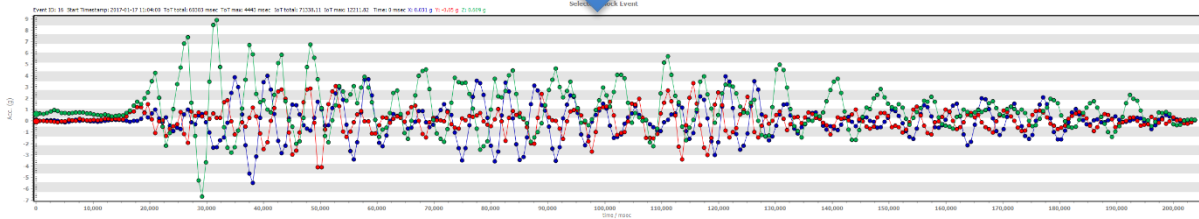
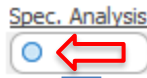

13.2 Power Spectrum (Power Spec)

The range of services is also a spectral analysis. In the 'Spec. Analysis' under 'Spectrum Type' – 'Power Spec' and under 'Weighting Win' – 'Blackman-Harris' or 'Blackman-Nuttall'.

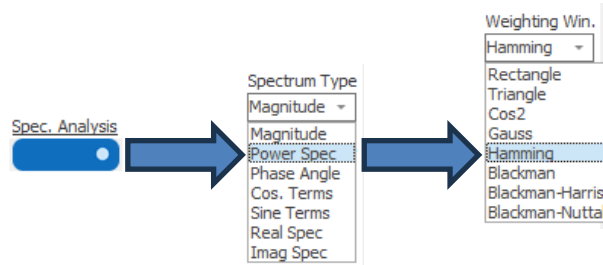

Power Spec - Blackman-Harris

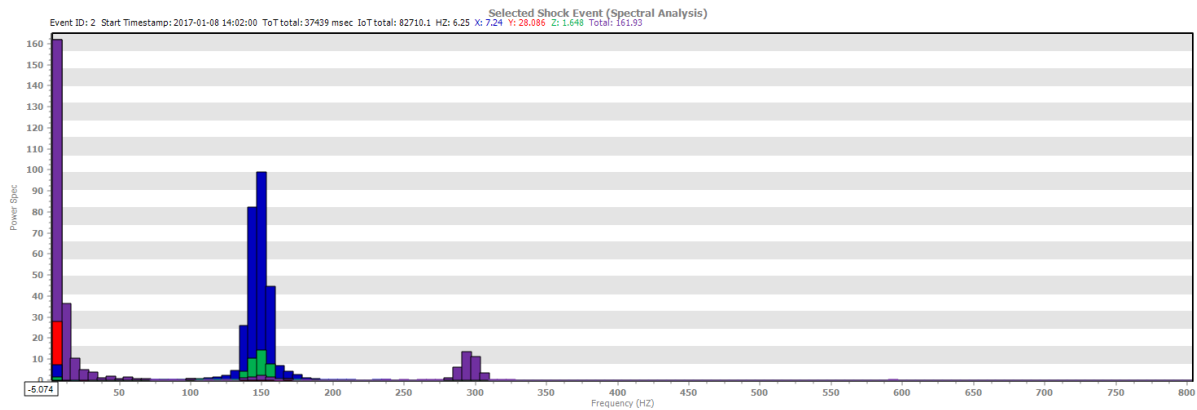

Blackman-Nuttall

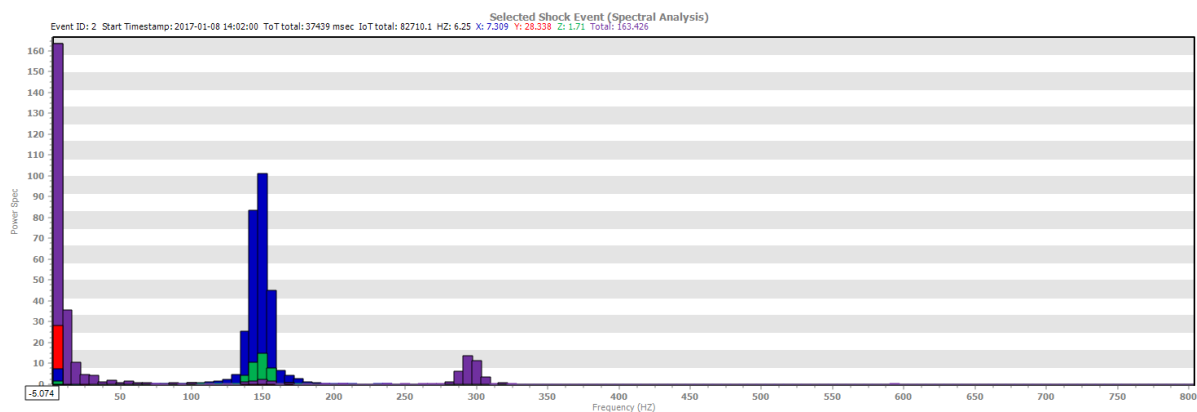

The same setting options are also available for the performance spectrum as for the other graphics cards (diagrams). All spectral analysis data can be exported as Excel / CSV or as an image / PDF.

We wish you every success with the data logger!

North American Distributor:

USA:

Interworld Electronics Inc.

Tel: 1.425.223.4311 - Toll Free: 1.877.902.2979

Fax: 1.877.FAX.IECI (329-4324)

E: sales@interworldusa.com

W: www.interworldna.com

Canada:

Interworld Electronics & Computer Ind. Inc

Tel: 1.604.925.6150 - Toll Free: 1.800.663.6001

E: sales@interworld.ca

W: www.interworldna.com